

The effective technology and complex services

Farmet[®]

PRODUCT RANGE

FARMET AGRICULTURAL MACHINERY



2025

MORE INNOVATION

NEW FALCON 6 COMPACT

page 64

COMPLETE RANGE
SOFTER PRO



page 15

COMPLETE RANGE
TRITON HEAVY



page 24

COMPLETE RANGE
KOMPAKTOMAT LONG



page 48

VISIT OUR PRODUCTION PLANT AND FIELD DAYS



REGISTER YOURSELF

PROFESSIONAL FIELD DAYS



EU HOMOLOGATION

FARMET a.s.
S2a
e8*167/2013*00060*00
FAR12580JK0000783
10000 kg
A-0: 3000 kg
A-1: 10000 kg
A-2: ----- kg
A-3: ----- kg

Farmet Jiřínková 276
552 03 Česká Skalice
MADE IN CZECH REPUBLIC

SOFTER SF12,5PS

ROK/ YEAR	2019	CELK. HMOTNOST/ TOTAL WEIGHT	13000 kg		
kg	T-1	T-2	T-3	 www.farmet.cz	
B-1	---	---	---		
B-2	---	---	---		
B-3	---	---	---		
B-4	---	---	---		

CE EAC



eXtra STEEL line®

ultra high strength steel technology

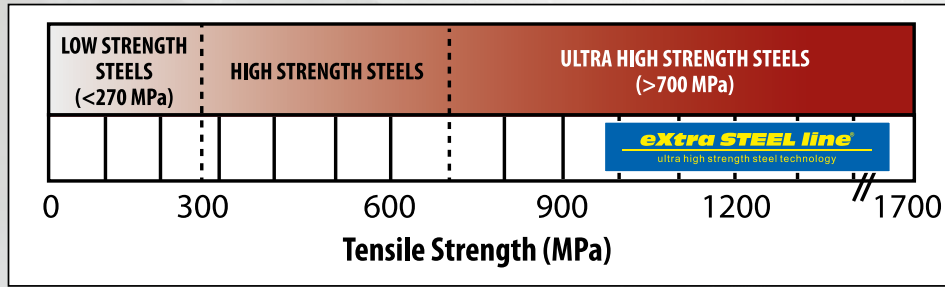

Frame from high-strength steel

- 3 times higher strength and high flexibility of construction
- Significantly lower weight of machine
- Used on frame, working units and extremely burdened parts
- For extended service life of machine
- Fuel economy

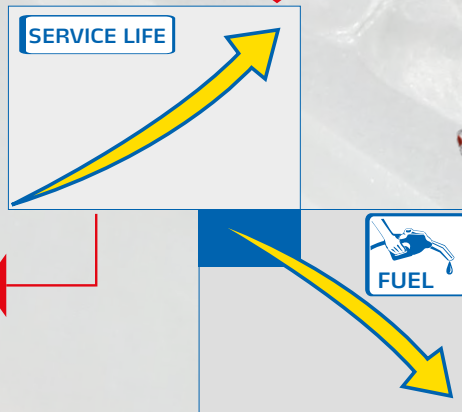

CONTENT

Product images in this catalog are illustrative and may not fully correspond to the actual design. We are constantly improving and innovating our products to provide the best possible solutions for current technological trends and to meet customer requirements. The current binding specifications / parameters of the products will be communicated on request.

TILLAGE

 | 4–15 cm (1.5"–6")

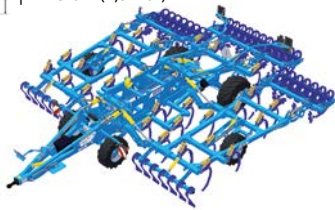

FANTOM

| 6

 | 3,5–12 cm (1.5"–4.75")



SOFTER
SOFTER & SYNCULT

| 10

 | 6–18 cm (2.25"–7")



DISKOMAT

| 16

TILLAGE AND DEEP LOOSENING

 | 10–35 cm (4"–13.75")



TERRIX QUATRO
TERRIX DUAL

| 20

 | 0–12 cm (0"–4.75")

 | 3–35 cm (1.25"–13.75")



TRITON

| 22

 | 6–21 cm (2.25"–8.25")

 | 20–40 cm (7.75"–15.75")

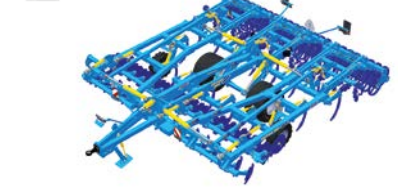

TRITON HEAVY

| 24

 | 6–35 cm (2.25"–13.75")

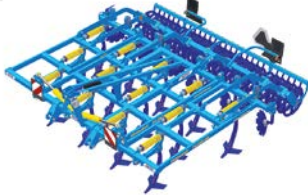

TRIOLENT
DUOLENT

| 26

 | 20–35 cm (7.75"–13.75")



STRIP-TILL

| 32

 | 25–50 cm (9.75"–19.5")



DIGGER

| 36

 | 25–50 cm (9.75"–19.5")



DIGGER FERT+
DIGGER FERT+ COMPACT

| 39

 | 50–60 cm (19.5"–23.5")



KRTEK

| 40

PRESOWING PREPARATION

 | 0–10 cm (0"–4")



KOMPAKTOMAT
KOMPAKTOMAT LONG

| 42

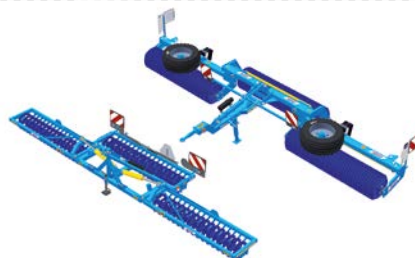

CAMBRIDGE
DV

| 52

 | 0–10 cm (0"–4")



VERSO

| 54

SOWING



FALCON COMPACT | 64



FALCON PRO | 66



FALCON TANDEM | 74



FALCON SW | 76



FALCON HW | 78



FREYA | 80



IMPACT | 82

FERTILISER APPLICATION



FALCON FH | 84



APPLICATION SETS | 85



MULTISTRIP & SYNCULT | 86
SOFTER & SYNCULT
STRIP-TILL & SYNCULT

OIL & FEED TECH



OIL & FEED TECH | 88

FANTOM

Full-surface stubble cultivation with intensive mixing.

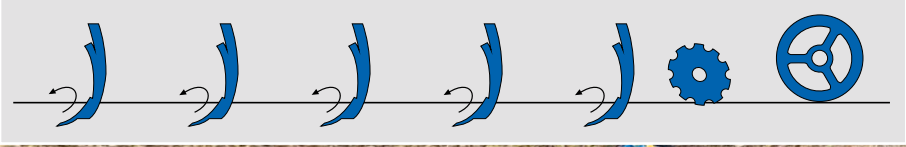

Cultivator Fantom is especially suitable for **full-surface post harvest stubble-cultivation with intensive mixing effect**. The soil is tilled up to the depth of 15 cm (6"). It allows stubble-cultivation, tillage and pre-sowing preparations.

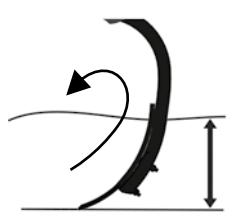

40–150 mm (1.5"–6")

8–12 km/h
5–8 mph

eXtra STEEL line
ultra high strength steel technology



N



NS



CLASSIC

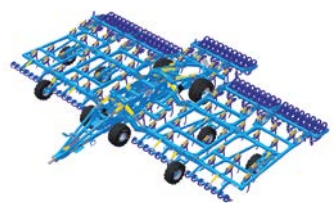

PRO



- Due to its design, the Fantom NS cultivator is **very versatile** and can be used for stubble cultivation, pre-sowing soil processing or incorporation of manure. Machine's low weight decreases by loading of the rear parts of tractors during transport. Thanks to its simple and massive design, the Fantom cultivator offers an **optimal compromise between the purchase price and utility value.**

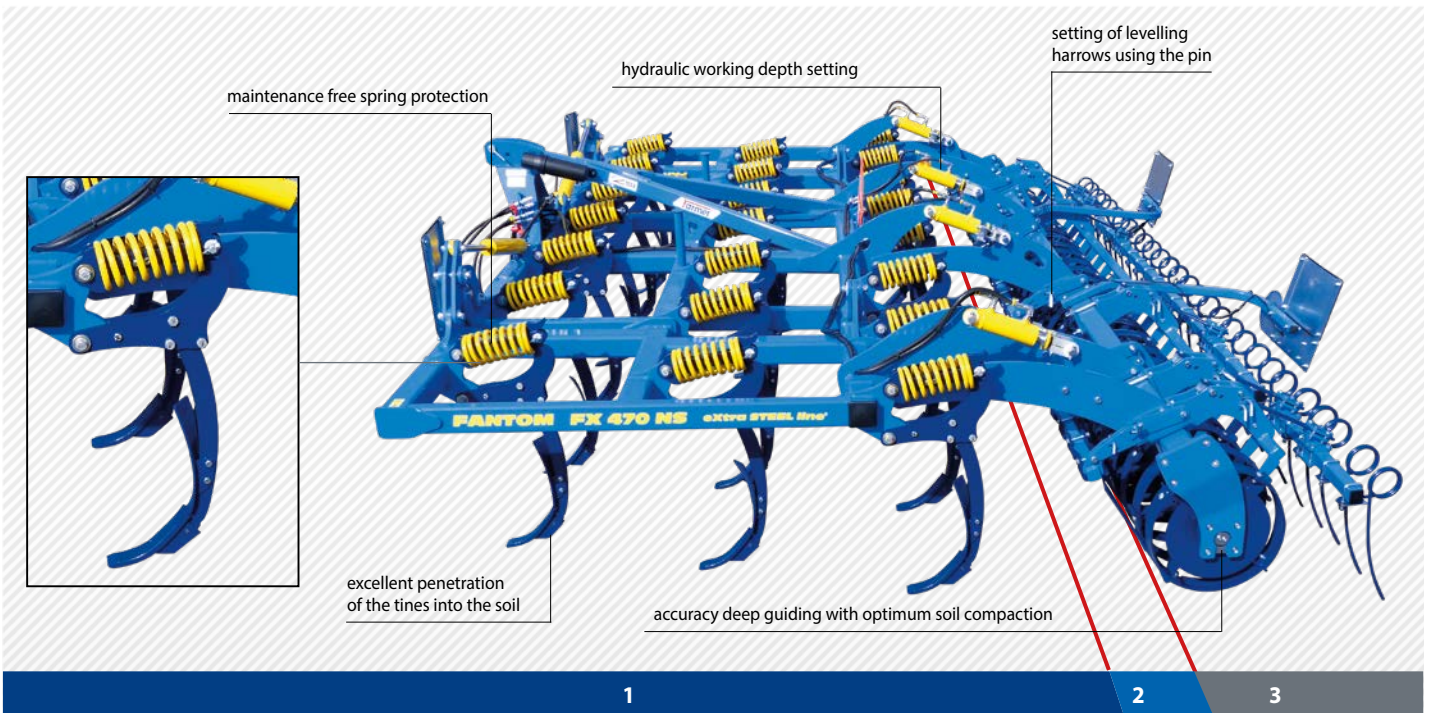
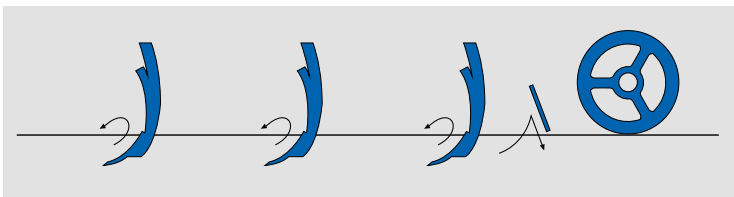

- The soil is tilled by the tines in three rows.
- The rod levelling bar ("RR" and "TR" roller) levels out the surface.
- The soil is compacted by the rear roller (Optional rollers, page 41).

Technical parameters	Units	Fantom 300 N	Fantom 350 N FIX	Fantom 470 NS
Working width	mm / ft	3000 / 9' 10"	3500 / 11' 6"	4700 / 15' 5"
Transport width	mm / ft	3000 / 9' 10"	3500 / 11' 6"	3000 / 9' 10"
Transport height	mm / ft	1330 / 4' 4"	1380 / 4' 6"	1930 / 6' 4"
Total machine length	mm / ft	3330 / 10' 11"	3330 / 10' 11"	3450 / 11' 4"
Working depth	mm / in	40–150 / 1.5"–6"	40–150 / 1.5"–6"	40–150 / 1.5"–6"
Number of tines	pcs	13	16	22
Working performance	ha/h (ac/h)	2.4–3.6 / 5.9–8.9	2.8–4.2 / 6.9–10.4	3.7–5.5 / 9.1–13.6
Towing vehicle	kW / HP	110–165 / 150–225	120–180 / 160–240	150–225 / 200–300
Machine weight	kg / lb.	1200 / 2646	1350 / 2976	2000 / 4409

More info at www.farmet.eu



FANTOM CLASSIC



TILLAGE

there is a spring protection on the working units with the very high release force of 310 kg (683 lb.) on the tip of the tine

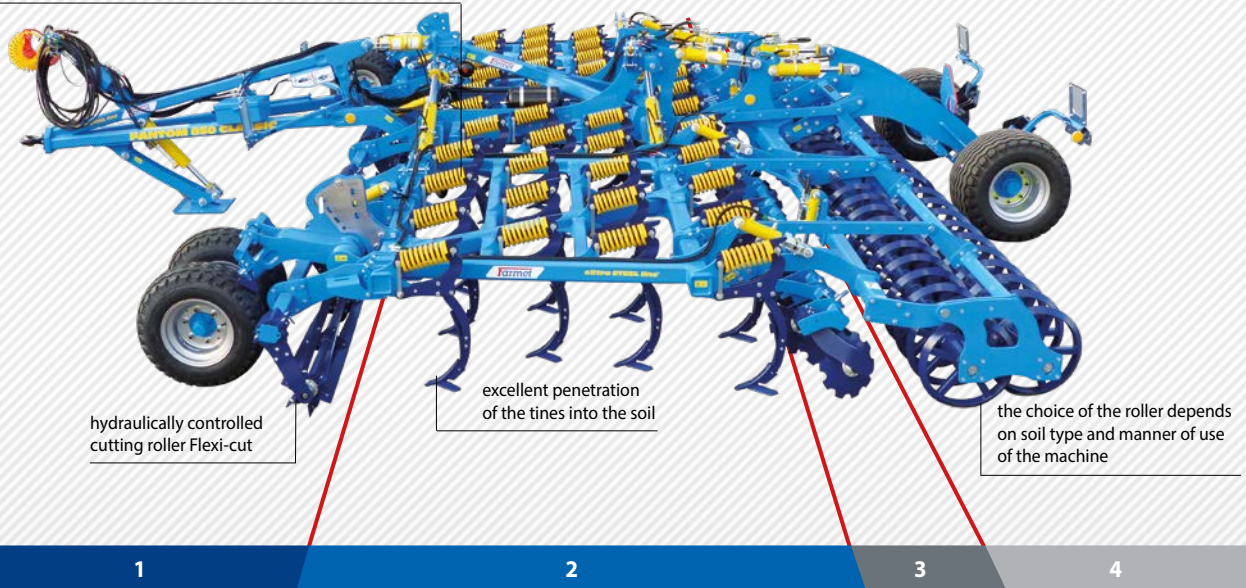

hydraulically controlled cutting roller Flexi-cut

excellent penetration of the tines into the soil

the choice of the roller depends on soil type and manner of use of the machine

1

2

3

4

1. Hydraulically controlled front flexi-board leveller for smoothing of the soil surface and crumbling of clods before the whole tillage.
2. Optional working units in 4 rows **A / B / C.**
3. The rear levelling discs located behind the working units in front of the row of rollers with the aim to level the soil surface in front of the rollers are easily height-adjustable.
4. Optional rear rollers for various conditions. (page 41).



Quick-change chisel system

A - standard

B - long life

C - stubble cultivation



reinforced carbide chisels

Technical parameters	Units	Fantom 650 CLASSIC	Fantom 850 CLASSIC	Fantom 1250 CLASSIC
Working width	mm / ft	6300 / 20' 8"	8550 / 28' 0"	12500 / 40' 2"
Transport width	mm / ft	3000 / 9' 10"	3000 / 9' 10"	3000 / 9' 10"
Working depth	mm / in	40–150 / 1.5"–6"	40–150 / 1.5"–6"	40–150 / 1.5"–6"
Number of tines	pcs	33	45	65
Working performance	ha/h ac/h	4.4–7.2 10.9–17.8	6.8–10.2 16.8–25.2	10.0–15.0 24.7–37.1
Towing vehicle	kW HP	200–300 270–410	245–370 330–500	330–440 450–675
Machine weight	kg / lb.	7000 / 15432	8500 / 19621	12400 / 27337

More info at www.farmet.eu



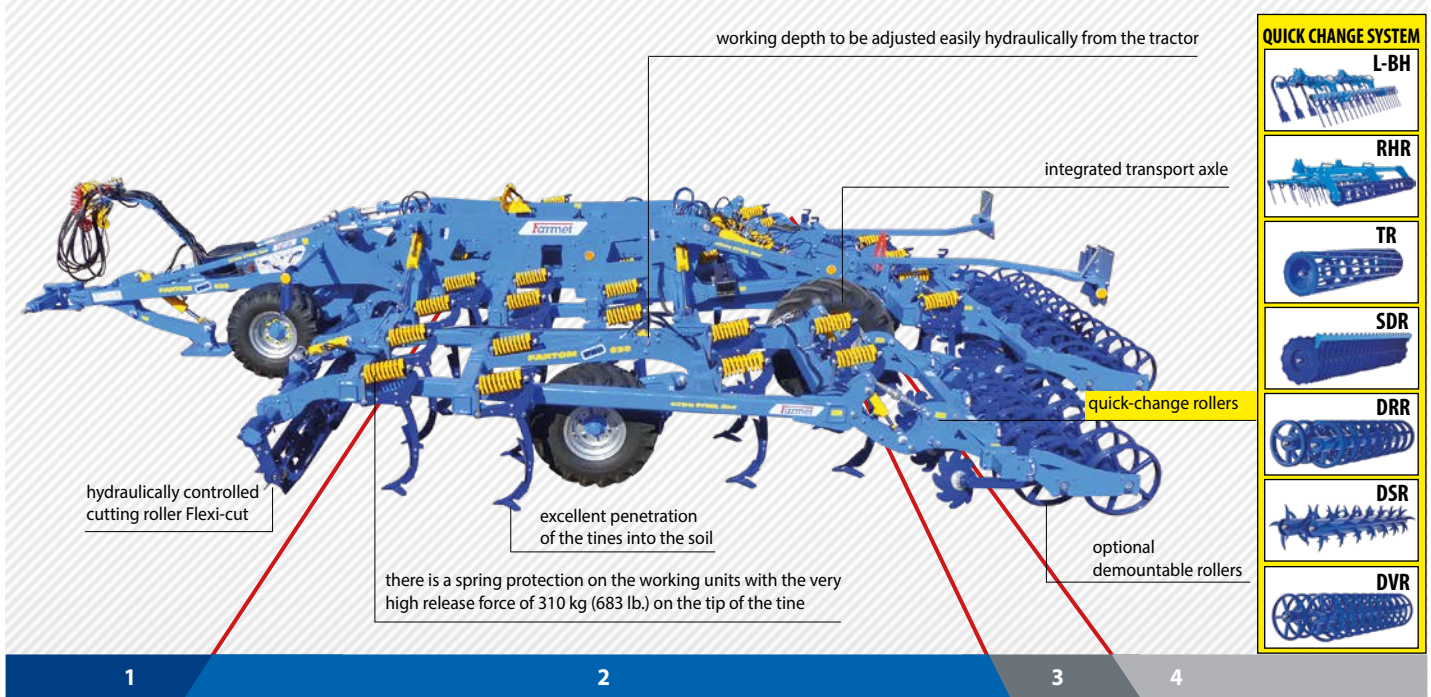

1. Hydraulically controlled front roller Flexi-cut for effective cutting up of crop residues.
2. Optional working units in 5 rows **A / B / C.**
3. The rear levelling discs located behind the working units in front of the row of rollers with the aim to level the soil surface in front of the rollers are easily height-adjustable.
4. Optional rear rollers for various conditions. (page 41). **Option of working without the optional rollers and levelling discs.**



The semi-mounted 5-row modular Fantom PRO cultivator with a low pulling requirement and a variable tillage depth is suitable for spring, summer and autumn work and due to its modularity it can start the spring work very soon since it can handle even more wet soil.

Technical parameters	Units	Fantom 650 PRO	Fantom 800 PRO	Fantom 850 PRO	Fantom 1050 PRO	Fantom 1250 PRO
Working width	mm / ft	6550 / 21' 6"	8050 / 26' 5"	8450 / 27' 8"	10350 / 33' 11"	12250 / 40' 2"
Transport width	mm / ft	3000 / 9' 10"	3000 / 9' 10"	3000 / 9' 10"	3000 / 9' 10"	3000 / 9' 10"
Working depth	mm / in	40–150 / 1.5"–6"	40–150 / 1.5"–6"	40–150 / 1.5"–6"	40–150 / 1.5"–6"	40–150 / 1.5"–6"
Number of tines	pcs	35	43	45	57	67
Working performance	ha/h (ac/h)	5.2–7.8 / 12.8–19.3	6.4–9.6 / 15.8–23.7	6.8–10.2 / 16.8–25.2	8.4–12.6 / 20.8–31.1	10.0–15.0 / 24.7–37.1
Towing vehicle	kW / HP	200–300 / 270–405	230–350/310–475	245–370 / 330–495	295–400 / 400–550	400–440 / 550–675
Machine weight	kg / lb.	8300 / 18298	9300 / 20503	9500 / 20944	12700 / 27998	13800 / 30423

More info at www.farmet.eu



SOFTER

Quick and effective cultivation

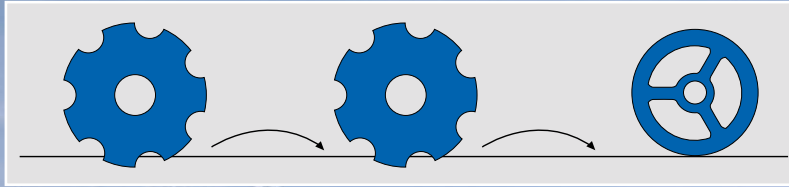



Disc cultivator Softer is especially suitable for shallow stubble-cultivation with perfect undercut and intensively mixed crop residues. It incorporates organic fertiliser, catch crops or difficult vegetation. **Intensively prepares the seed bed** after stubble-cultivation or ploughing with optimum recompaction of the soil.

- Ø 510 mm (20")
- Ø 530 mm (21")
- Ø 560 mm (22")

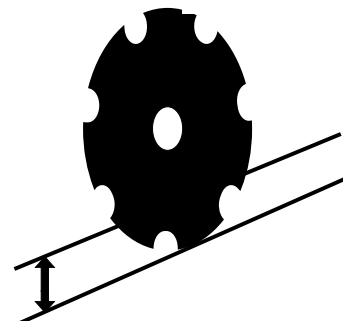

35–120 mm (1,5"–4,75")

10–15 km/h
(6–9 mph)



N

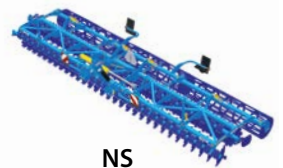

NS



PS



PS



PRO

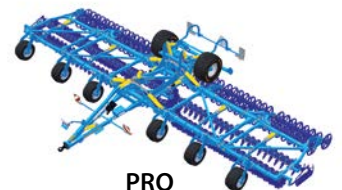

PRO

eXtra STEEL line®
ultra high strength steel technology

SOFTER

- The main advantage of disc cultivator Softer is a **universal usage from the first stubble-cultivation to subsequent pre-sowing preparation of the soil** after the stubble-cultivation or ploughing.
- **Simple design with increased resistance.** When used with a tractor of sufficient traction power, Softer enables preparation of soil with **speeds up to 15 km/h (9 mph)**. It guarantees easy incorporation of crop residues into the top-soil after harvest. Softer is characterized with **simple design with increased resistance, compactness and versatility** with a minimum of adjusting and lubricating points. High pressure to each disc together with serrated circumference ensures optimum penetration even to heavy and over-dried soil.
- Very short design of the machine results in **precise deep guiding, excellent stability at work and effective quick turning at headlands.**

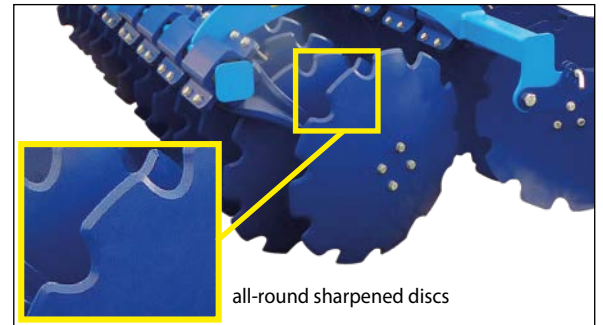

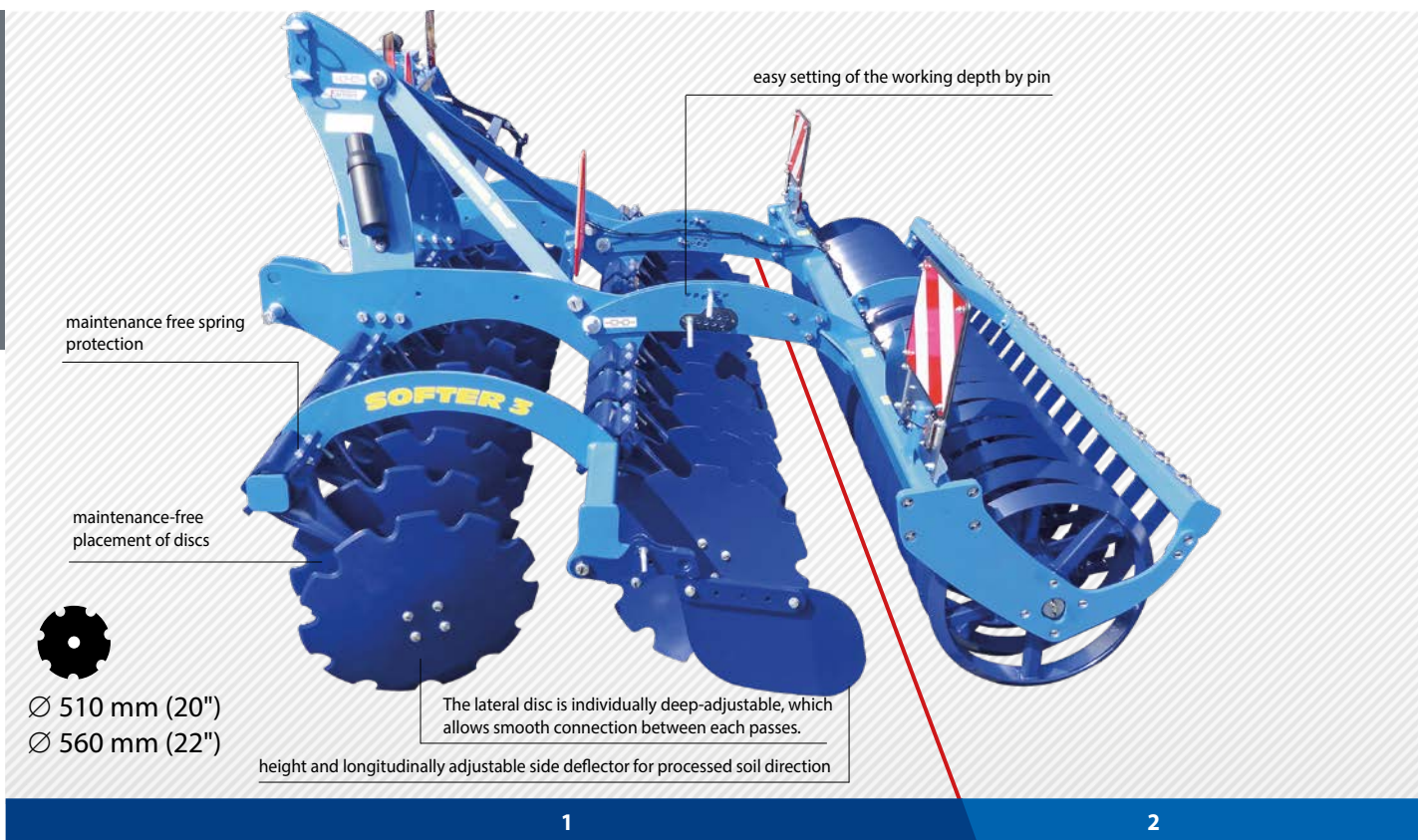

1. Discs with the diameter of 510 mm / 560 mm (20" / 22") arranged in two rows will undercut the soil. Working depth is 3,5–12 cm (1.5"–4.75").
2. Clods are crumbled by the rear roller. (Optional rollers, page 41).



NEW

Technical parameters	Units	Softer 2,5 N	Softer 3 N	Softer 3,5 N FIX	Softer 4 N FIX	Softer 4,5 NS* Softer 4,5 NS Syncult	Softer 5 NS* Softer 5 NS Syncult	Softer 6 NS* Softer 6 NS Syncult	Softer 8 NS* Softer 8 NS Syncult
Working width	mm / ft	2550 / 8' 4"	3000 / 9' 10"	3500 / 11' 1"	3990 / 13' 1"	4470 / 14' 8"	4950 / 16' 3"	5910 / 19' 5"	7400 / 24' 3"
Transport width	mm / ft	2550 / 8' 4"	3000 / 9' 10"	3500 / 11' 1"	4390 / 14' 5"	3000 / 9' 10"	3000 / 9' 10"	3000 / 9' 10"	3000 / 9' 10"
Transport height	mm / ft	1420 / 4' 8"	1420 / 4' 8"	1420 / 4' 8"	1620 / 5' 4"	2500 / 8' 2"	2750 / 9'	3250 / 10' 8"	4000 / 13' 1"
Total machine length	mm / ft	2750 / 9'	2750 / 9'	2750 / 9'	2800 / 9' 2"	2750 / 9'	2750 / 9'	2750 / 9'	2750 / 9'
Working depth	mm / in	35–130 / 1.5"–5"	35–130 / 1.5"–5"	35–130 / 1.5"–5"	35–130 / 1.5"–5"	35–130 / 1.5"–5"	35–130 / 1.5"–5"	35–130 / 1.5"–5"	35–130 / 1.5"–5"
Number of discs	pcs	20	24	28	33	37	41	49	61
Working performance	ha/h (ac/h)	2.5–3.8 / 6.2–9.4	3–4.5 / 7.4–11.1	3.5–5.3 / 8.6–13.1	4.0–6.0 / 9.9–14.8	4.5–6.75 / 11.1–16.7	5–7.5 / 12.3–18.5	6–9 / 14.8–22.2	8–12 / 19.8–29.7
Towing vehicle	kW / HP	65–100 / 90–140	80–120 / 110–165	90–140 / 120–190	110–160 / 150–220	120–180 / 160–240*	130–190 / 180–260*	150–225 / 200–300*	200–300 / 270–405*
Machine weight	kg / lb.	1800 / 3968	1980 / 4365	2300 / 5071	2700 / 5952	3200 / 7055*	3450 / 7606*	3900 / 8598*	4770 / 10516*

More info at www.farmet.eu

SOFTER & SYNCULT

Ø 510 mm(20")

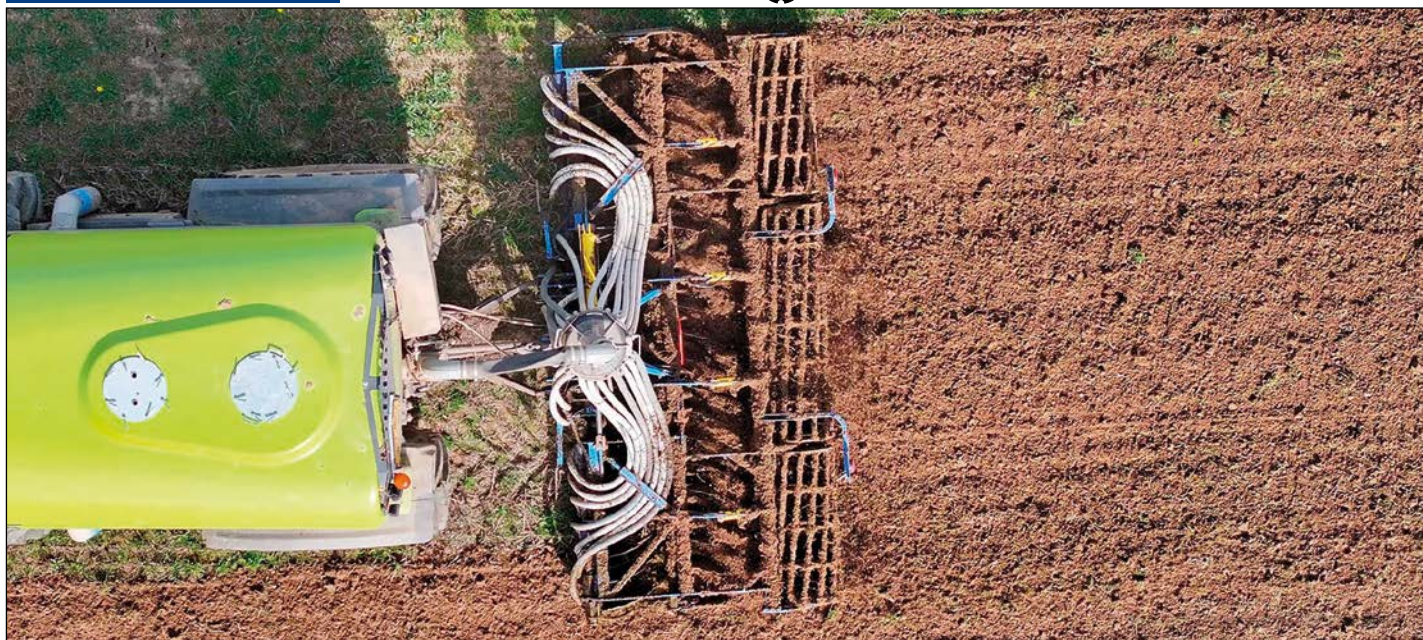

SOFTER PS



TILLAGE

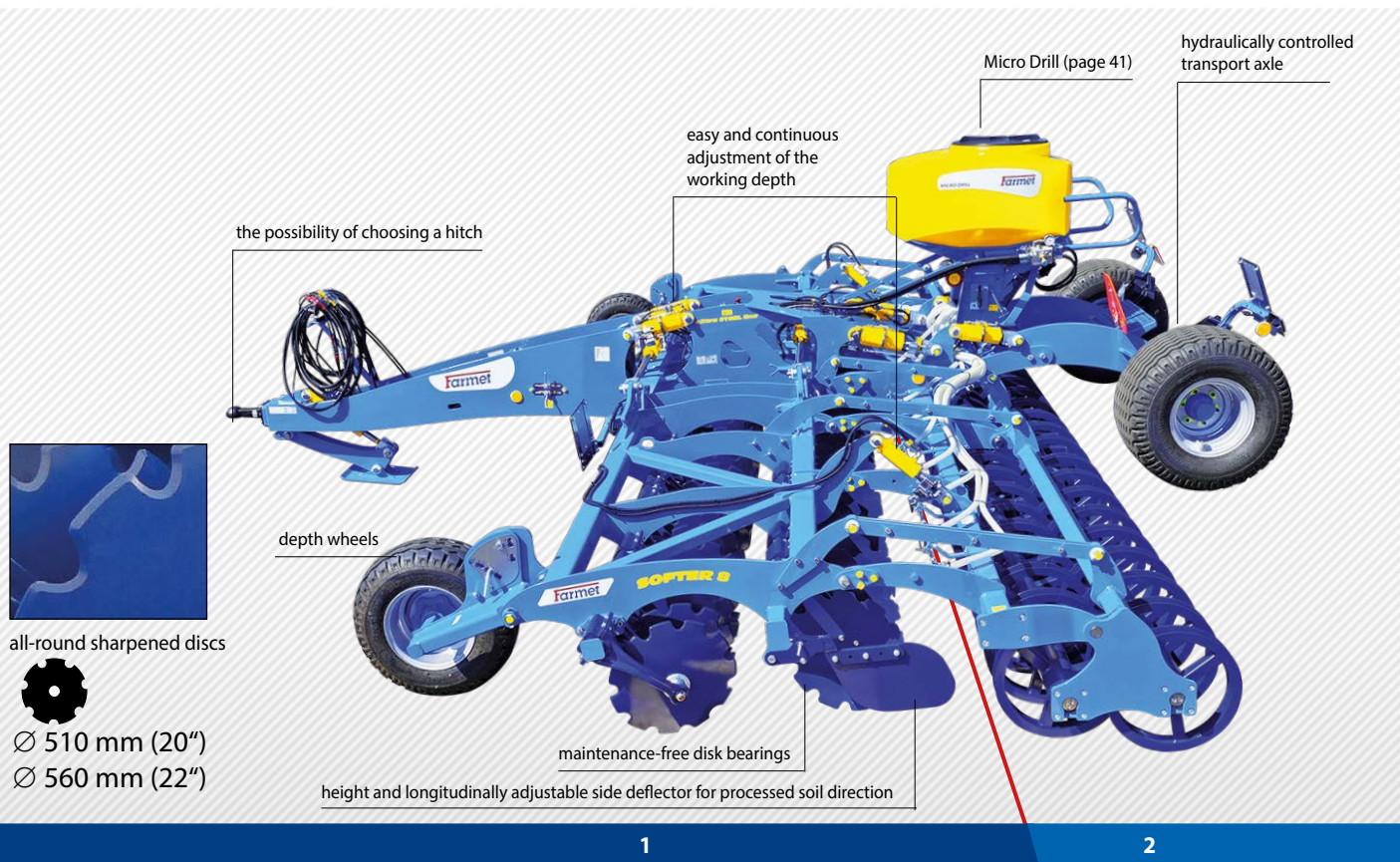

1. Discs with the diameter of 510 mm / 560 mm (20" / 22") arranged in two rows undercut the soil. Working depth is 3,5–13 cm (1.5"–5").
2. Clods are crumbled by the rear roller. (Optional rollers, page 41).



Technical parameters	Units	Softer 4 P FIX	Softer 4,5 PS	Softer 5 PS	Softer 6 PS	Softer 8 PS	Softer 9 PS W	Softer 11 PS	Softer 12 PS W
Working width	mm / ft	3990 / 13' 1"	4470 / 14' 8"	4950 / 16' 3"	5910 / 19' 5"	7360 / 24' 2"	8320 / 27' 3"	10690 / 35' 1"	11670 / 38' 3"
Transport width	mm / ft	4330 / 14' 2"	3000 / 9' 10"	3000 / 9' 10"	3000 / 9' 10"	3000 / 9' 10"	4000 / 13' 1"	3000 / 9' 10"	4000 / 13' 1"
Transport height	mm / ft	1600 / 5' 3"	2650 / 8' 8"	2900 / 9' 6"	3370 / 11' 1"	4000 / 13' 1"	4000 / 13' 1"	4000 / 13' 1"	4000 / 13' 1"
Total machine length	mm / ft	6675 / 21' 11"	6675 / 21' 11"	6675 / 21' 11"	6675 / 21' 11"	6850 / 22' 6"	6850 / 22' 6"	6850 / 22' 6"	6850 / 22' 6"
Working depth	mm in	35–130 1.5"–5"	35–130 1.5"–5"	35–130 1.5"–5"	35–130 1.5"–5"	35–130 1.5"–5"	35–130 1.5"–5"	35–130 1.5"–5"	35–130 1.5"–5"
Number of discs	pcs	33	37	41	49	61	69	89	97
Working performance	ha/h ac/h	4.0–6.0 9.9–14.8	4.5–6.8 11.1–16.8	5.0–7.5 12.4–18.5	6–9 14.8–22.2	8–12 19.8–29.7	9.0–13.5 22.2–33.4	11–16.5 27.2–40.8	12.0–18.1 29.7–44.7
Towing vehicle	kW HP	110–160 150–215	120–180 160–240	130–190 175–255	150–225 200–300	200–300 270–405	220–320 295–430	245–370 330–495	280–410 380–550
Machine weight	kg / lb.	3600 / 7937	4000 / 8818	4350 / 9590	4990 / 11001	6700 / 14771	7600 / 16755	9200 / 20282	10920 / 24074

More info at www.farmet.eu



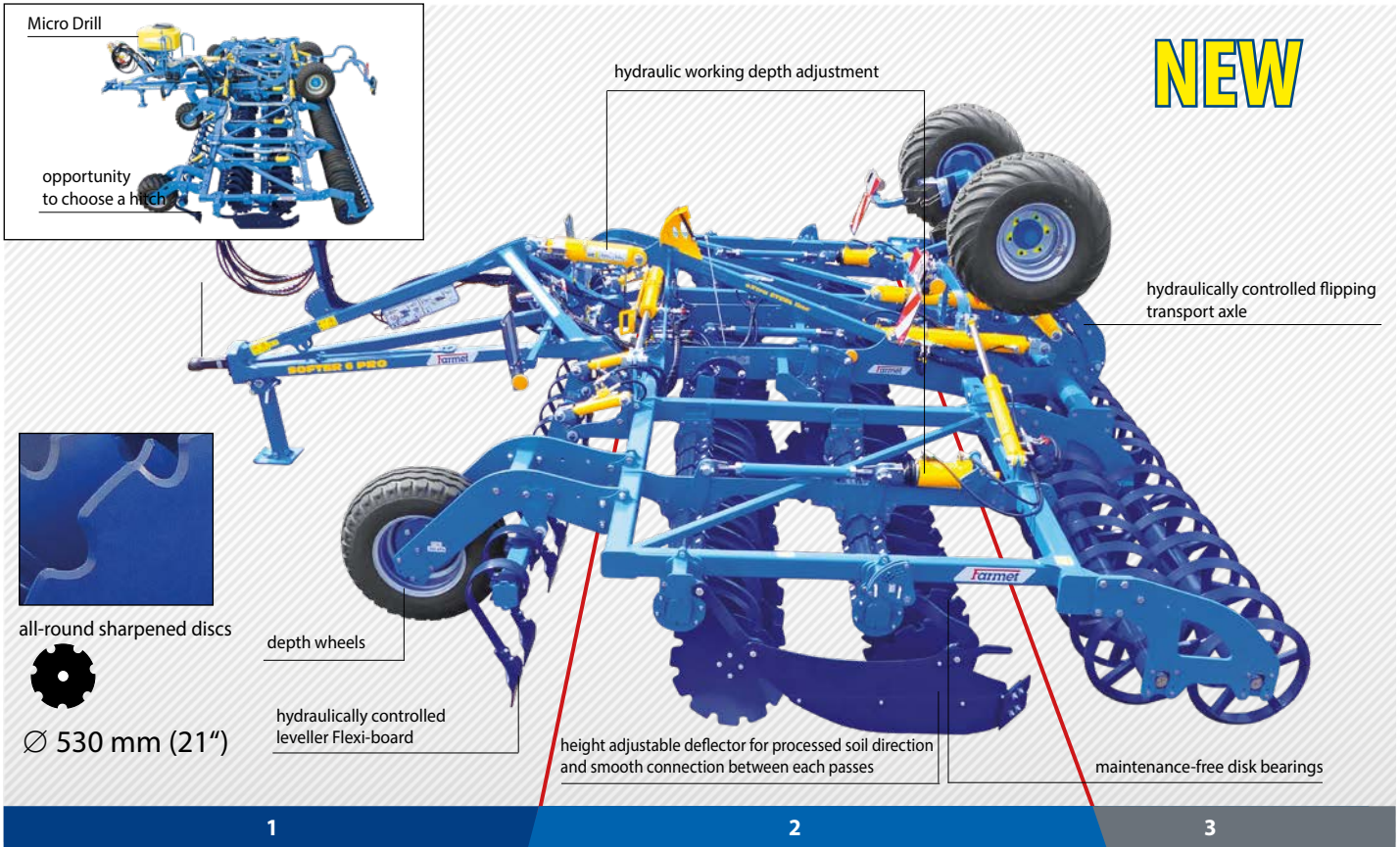

1. Possibility to install front tools: Flexi-cut for effective crop residue sizing or Flexi-board for leveling soil surface.
2. Discs with the diameter of 530 mm (21") arranged in two rows undercut the soil. Working depth is 3,5–13 cm (1.5"–5").
3. Clods are crumbled by the rear roller. (Optional rollers, page 41).

Technical parameters	Units	Softer 500 PRO	Softer 600 PRO	Softer 700 PRO	Softer 800 PRO	Softer 1050 PRO	Softer 1250 PRO
Working width	mm / ft	4930 / 16' 2"	5900 / 19' 4"	6850 / 22' 6"	7560 / 24' 9"	10400 / 34' 1"	12350 / 40' 6"
Transport width	mm / ft	3000 / 9' 10"	3000 / 9' 10"	3000 / 9' 10"	3000 / 9' 10"	3000 / 9' 10"	3000 / 9' 10"
Transport height	mm / ft	2700 / 8' 10"	3180 / 10' 5"	3660 / 12'	4000 / 13' 1"	3850 / 12' 7"	4000 / 13' 1"
Total machine length	mm / ft	7300 / 23' 11"	7300 / 23' 11"	7300 / 23' 11"	7300 / 23' 11"	7900 / 25' 11"	7900 / 25' 11"
Working depth	mm in	35–130 1.5"–5"	35–130 1.5"–5"	35–130 1.5"–5"	35–130 1.5"–5"	35–130 1.5"–5"	35–130 1.5"–5"
Number of discs	pcs	41	49	57	63	89	105
Working performance	ha/h ac/h	4.8–7.2 11.9–17.8	5.7–8.6 14.1–21.3	6.7–10.0 16.6–24.7	7.6–11.4 18.8–28.2	10.5–16.0 25.9–39.5	12.0–18.0 29.7–44.5
Towing vehicle	kW HP	130–190 175–255	150–225 200–300	175–260 240–360	200–300 270–405	265–400 355–540	305–465 410–630
Machine weight	kg / lb.	5600 / 12346	6400 / 14109	7300 / 16093	8200 / 18078	13000 / 28660	13800 / 30423

More info at www.farmet.eu



DISKOMAT

Intensive soil mixing and tillage up to the depth of 18 cm (7")

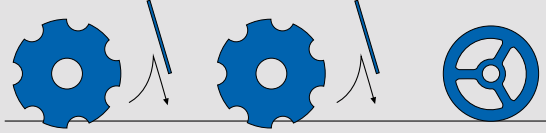

Disc cultivators Diskomat is especially suitable for stubble-cultivation with intensively mixed stubble and tillage up to the depth of 18 cm (7"). It incorporates large quantities of organic matter, e.g. corn, organic fertiliser, catch crops or high weed infestation. Intensively prepares the seedbed with optimum soil compaction. Perfectly undercuts the tilled soil profile.

Ø 620 mm (24.5")

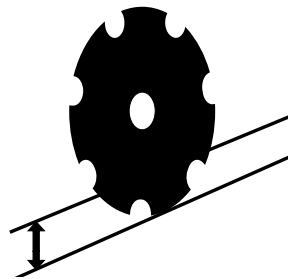

60–180 mm (2.5"–7")

10–15 km/h
(6–9 mph)

eXtra STEEL line®
ultra high strength steel technology



N



PS



PS

- A great advantage of the conception of the machine is the generally known levelling effect so the disc cultivator is also suitable for **pre-sowing soil tillage** when emphasis is put on **good levelling of the land** and quality soil processing.
- Disc cultivator Diskomat is unique in the **overall construction and design** as well as in the solution of the individual technical nodes and the use of special material technologies. That provides the machine with very **compact dimensions** (mainly for transport on the public road, **very low weight** and its favourable distribution onto the working units and particularly **very low maintenance requirements**.
- There are **several types of rear rollers** depending on the soil conditions. The integrated transport axle with braked wheels is a part of the double rubber-tyred roller.
- Great emphasis is put on the overall design and ergonomics of the machine. All adjusting nodes are easily accessible to the operator and meet strict safety requirements. Most controlling elements are solved by hydraulics and can be comfortably regulated directly from the operator's position in the tractor during work.



DISKOMAT N

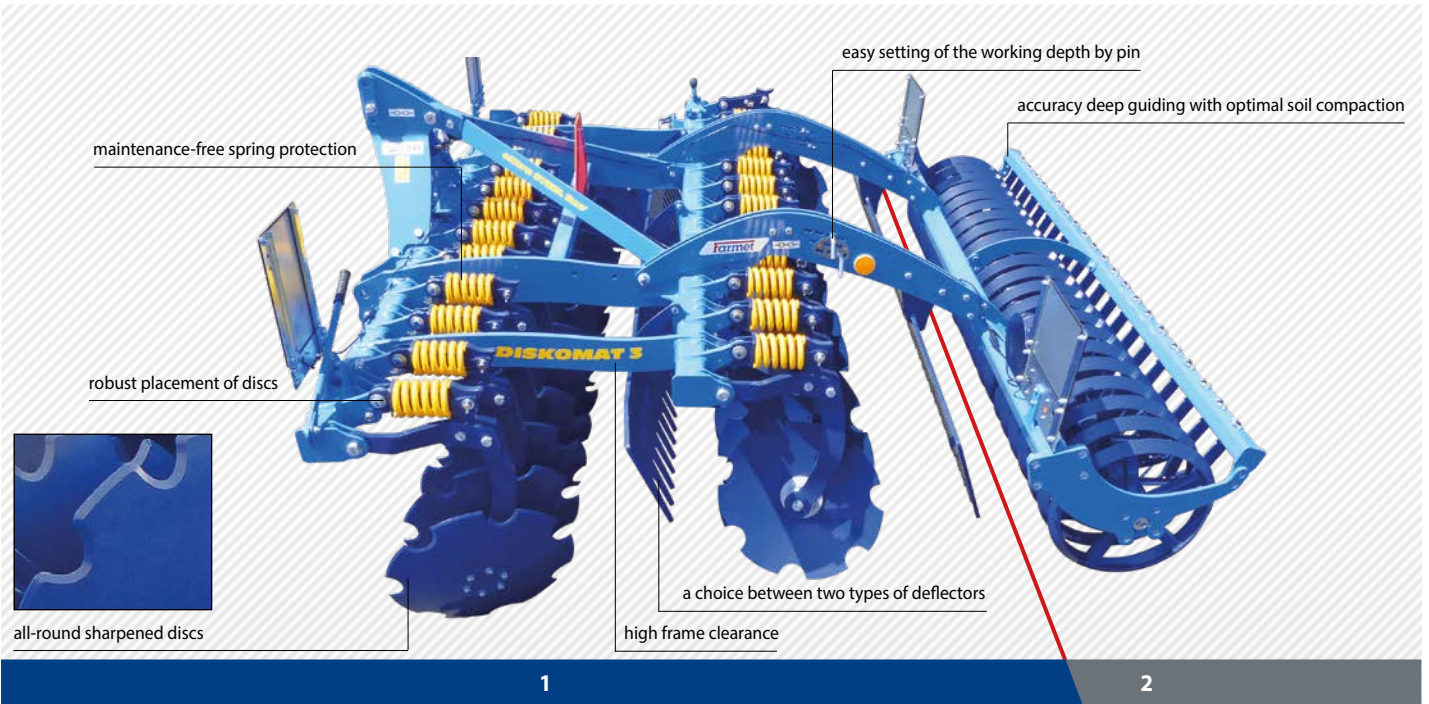

1. Discs with diameter of 620 mm (24.5") arranged in two rows will undercut the soil. There is a deflector behind each row of discs for crumbling flying clods.
2. Clods are crumbled by the rear roller. (Optional rollers, page 41).



Technical parameters	Units	Diskomat 3 N	Diskomat 3,5 N FIX
Working width	mm / ft	3000 / 9' 10"	3500 / 11' 5"
Transport width	mm / ft	3000 / 9' 10"	3500 / 11' 5"
Transport height	mm / ft	1600 / 5' 3"	1600 / 5' 3"
Total machine length	mm / ft	3300 / 10' 9"	3300 / 10' 9"
Working depth	mm / in	50-180 / 2.5"-7"	50-180 / 2.5"-7"
Number of discs	pcs	12 / 12	14 / 14
Working performance	ha/h ac/h	3.0-4.5 7.4-11.1	3.5-5.25 8.6-13
Towing vehicle	kW / HP	105-158 / 140-165	120-180 / 160-240
Machine weight	kg / lb.	2400 / 5291	2600 / 5732

More info at www.farmet.eu



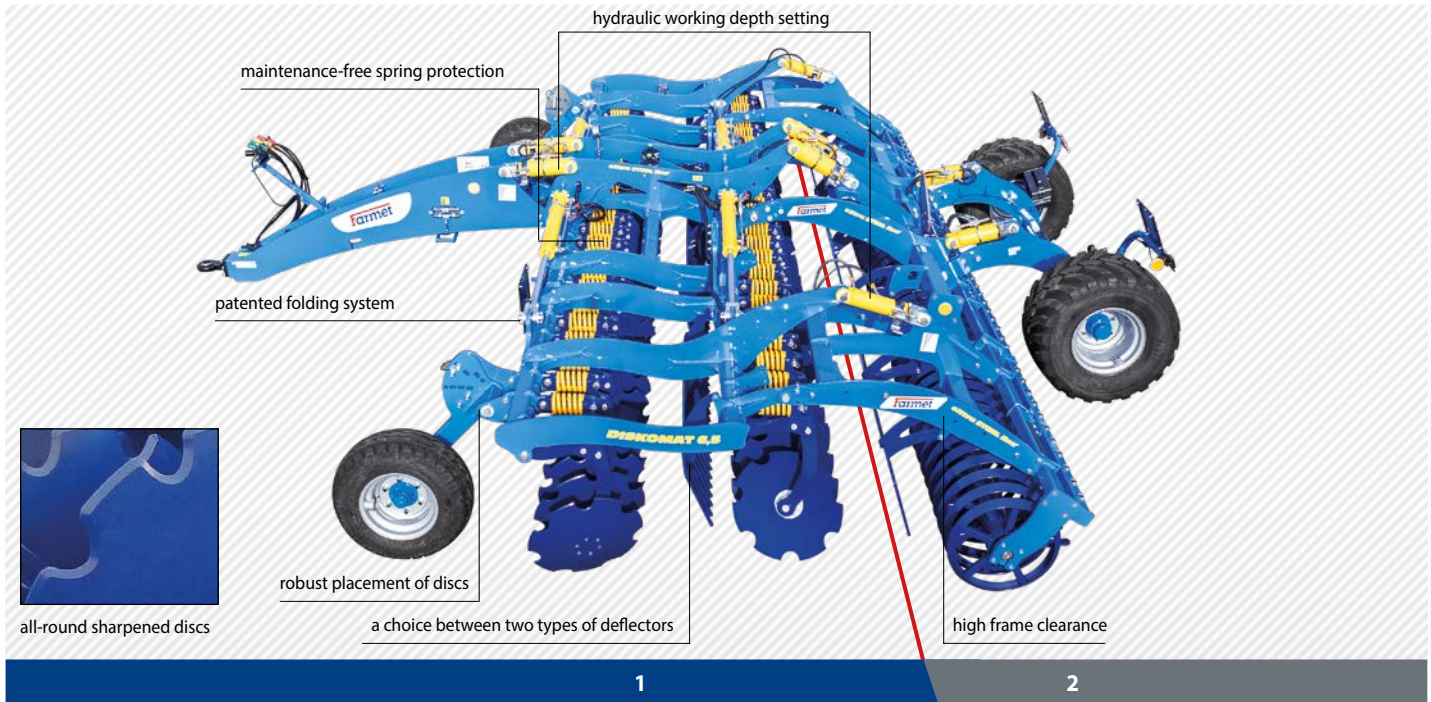

1. Discs with the diameter of 620 mm (24.5") arranged in two rows undercut the soil. There is a deflector behind each row of discs for crumbling flying clods.
2. Clods are crumbled by the rear roller. (Optional rollers, page 41).



Technical parameters	Units	Diskomat 5 PS	Diskomat 6 PS	Diskomat 6,5 PS W	Diskomat 8 PS	Diskomat 8,5 PS W
Working width	mm / ft	5000 / 16' 5"	6000 / 19' 8"	6300 / 20' 8"	7800 / 25' 7"	8300 / 27' 3"
Transport width	mm / ft	3000 / 9' 10"	3000 / 9' 10"	3250 / 10' 8"	3000 / 9' 10"	3750 / 12' 4"
Transport height	mm / ft	3300 / 10' 10"	3650 / 11' 12"	4000 / 13' 1"	4000 / 13' 1"	4000 / 13' 1"
Total machine length	mm / ft	6600 / 21' 8"	6600 / 21' 8"	6600 / 21' 8"	6600 / 21' 8"	7250 / 23' 9"
Working depth	mm / in	60–180 / 2.5"–7"	60–180 / 2.5"–7"	60–180 / 2.5"–7"	60–180 / 2.5"–7"	60–180 / 2.5"–7"
Number of discs	pcs	20 / 20	24 / 24	25 / 25	30 / 30	33 / 33
Working performance	ha/h (ac/h)	5.0–7.5 / 12.4–18.5	6.0–9.0 / 14.8–22.2	6.3–9.5 / 15.6–23.5	8.0–12.0 / 19.8–29.7	8.5–13.0 / 21–32.1
Towing vehicle	kW / HP	150–220 / 205–300	180–260 / 245–355	190–270 / 260–370	240–300 / 325–410	260–330 / 355–450
Machine weight	kg / lb.	6200 / 13668	6950 / 15322	7850 / 17306	8660 / 19092	10000 / 22046



More info at www.farmet.eu

TERRIX QUATRO

TERRIX DUAL



Full-surface tillage up to the depth of 35 cm (13.75")
with intensive mixing effect

TILLAGE AND DEEP LOOSENING



8–12 km/h
(5–8 mph)

TERRIX QUATRO



TERRIX DUAL



- A four-row tine cultivator **TERRIX QUATRO** with a wide range of application from shallow stubble cultivation to deep soil tillage of up to 35 cm (13.75"). Full-surface tillage of processed horizon with intense mixing of crop residue. Highly versatile and suitable for all types of soil.
- The four-row **TERRIX DUAL** tine cultivator operates on the principle of gradual soil tillage up to a working depth of 35 cm (13.75"). This gives a significantly better quality of tillage and a very high, two-level effect of crop residue incorporation. The soil surface is tilled both along the entire area and by deeper tillage in a one pass.

The four-row TERRIX tine cultivators ensure high soil and crop residue mixing, with excellent incorporation and levelling effect. While TERRIX QUATRO offers excellent soil tillage, TERRIX DUAL offers gradual deep loosening through the soil layers, achieving an even greater incorporation of crop residue and soil mixing.



100–350 mm
(4"–13.75")

NEW



550 kg
(1212 lb.)

extra STEEL line
ultra high strength steel technology



TERRIX QUATRO



TERRIX DUAL



TERRIX QUATRO

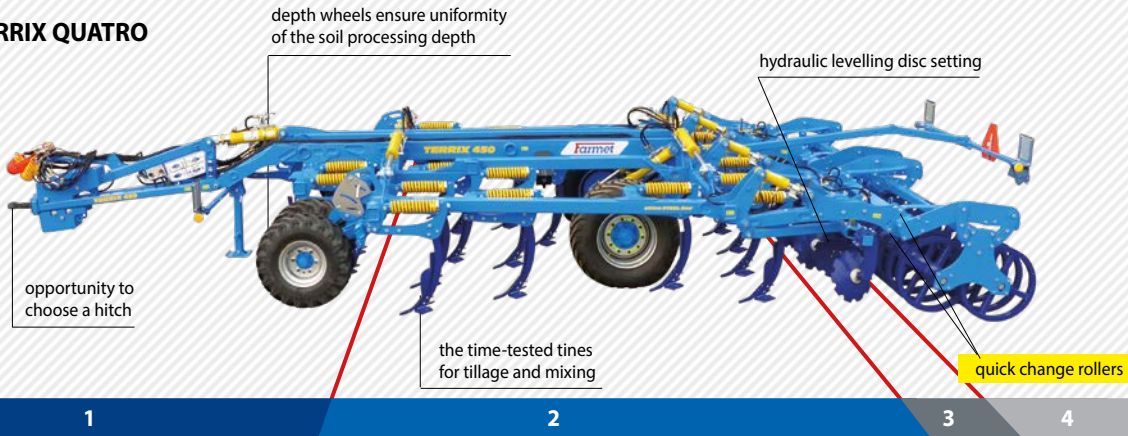

QUICK CHANGE SYSTEM

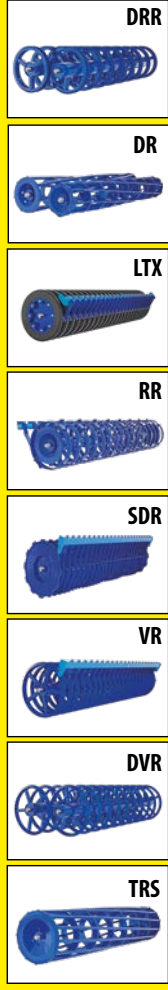

TERRIX DUAL

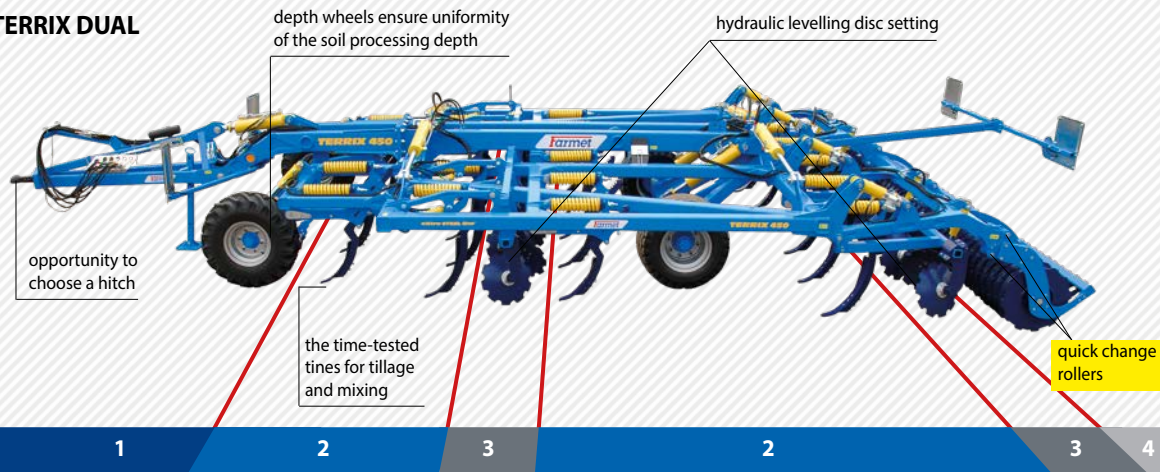

1. Depth wheels for uniform tillage of the soil.
2. Four rows of massive tines for stubble-cultivation and tillage up to the depth of 35 cm (13.75"). (Opt. chisels, page 35).
3. Levelling discs for fine structure of the soil on surface.
4. The rear roller provides good reverse compaction, crumbles the clods and levels the field surface. (Optional rollers, page 41). **Option of working without the optional rollers.**

TERRIX QUATRO

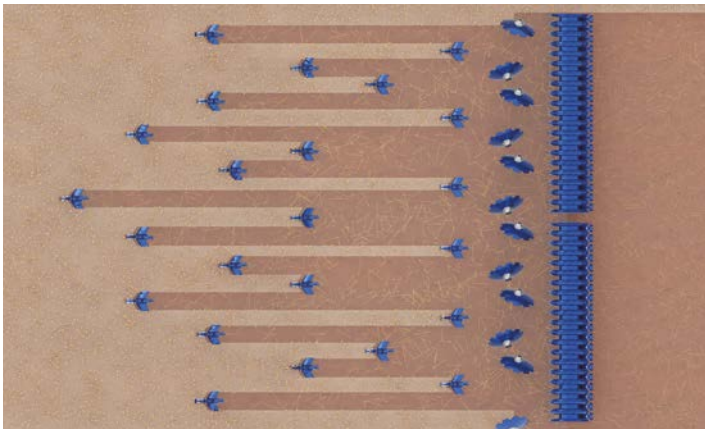

TERRIX DUAL

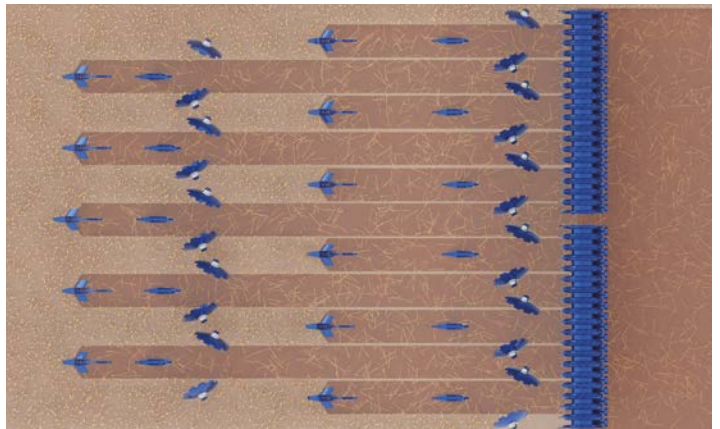

Technical parameters	Units	TERRIX QUATRO 450 PS	TERRIX QUATRO 600 PS	TERRIX DUAL 450 PS	TERRIX DUAL 600 PS
Working width	mm / ft	4500 / 14' 9"	6000 / 19' 8"	4500 / 14' 9"	6000 / 19' 8"
Transport width	mm / ft	3000 / 9' 10"	3000 / 9' 10"	3000 / 9' 10"	3000 / 9' 10"
Transport height	mm / ft	3340 / 10' 11"	4000 / 13' 1"	3340 / 10' 11"	4000 / 13' 1"
Total machine length	mm / ft	10500 / 34' 5"	10500 / 34' 5"	10500 / 34' 5"	10500 / 34' 5"
Working depth	mm / in	100–350 / 4"–13.75"	100–350 / 4"–13.75"	100–350 / 4"–13.75"	100–350 / 4"–13.75"
Number of tines	pcs	22	30	22	30
Working performance	ha/h ac/h	3.6–5.4 8.9–13.3	4.8–7.2 11.9–17.8	3.6–5.4 8.9–13.3	4.8–7.2 11.9–17.8
Towing vehicle	kW / HP	225–350 / 300–450	350–460 / 470–630	225–350 / 300–450	350–460 / 470–630
Machine weight	kg / lb.	8400 / 18519	10200 / 22487	7300 / 16093	8800 / 19400

More info at www.farmet.eu

TRITON



Full-surface soil processing with zone tillage up to the depth of 35 cm (13.75")

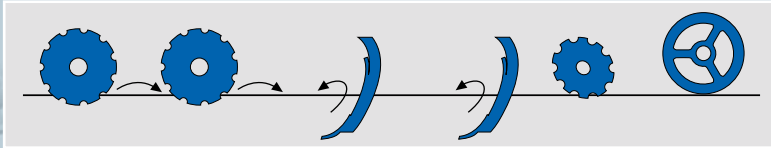

8–12 km/h
(5–8 mph)

- The combined disc-and- tine cultivator is ideal for working through heavier soils with a large quantity of crop residue. Trash is evenly mixed into the overall processed soil layer while the soil is tilled and worked by the different working elements.
- The Triton combination cultivator is equipped with two rows of discs of 510 mm (20") or 560 mm (22") diameter with maintenance-free overload protection. The discs have a working depth of 12 cm (4.75") and have excellent crop residue mixing properties. The following two rows of heavy duty tines have a wide spacing of 42 cm (1' 5") and loosen the soil up to 35 cm (13.75") depth, while allowing excellent water penetration through to the subsurface. The final row of levelling discs combined with the rear packer help to achieve a level and compacted surface.

The TRITON combination cultivator provides the advantages of disc cultivators and tine cultivators in one pass. The result is efficient cutting and mixing of crop residue into processed soil with deeper aeration providing excellent water penetration through the soil.

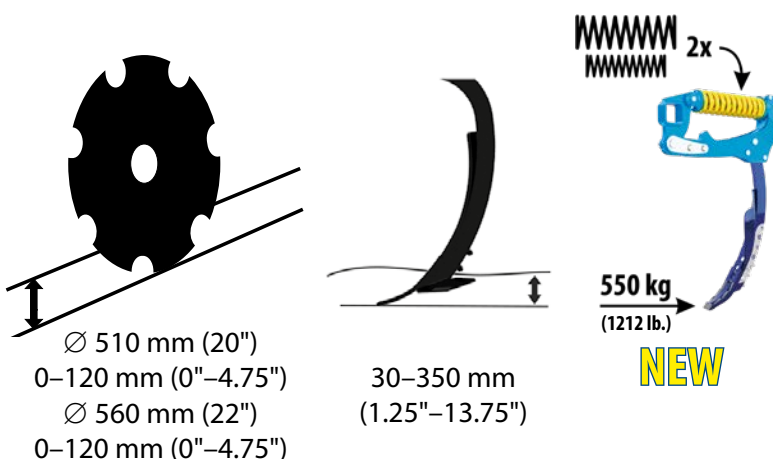

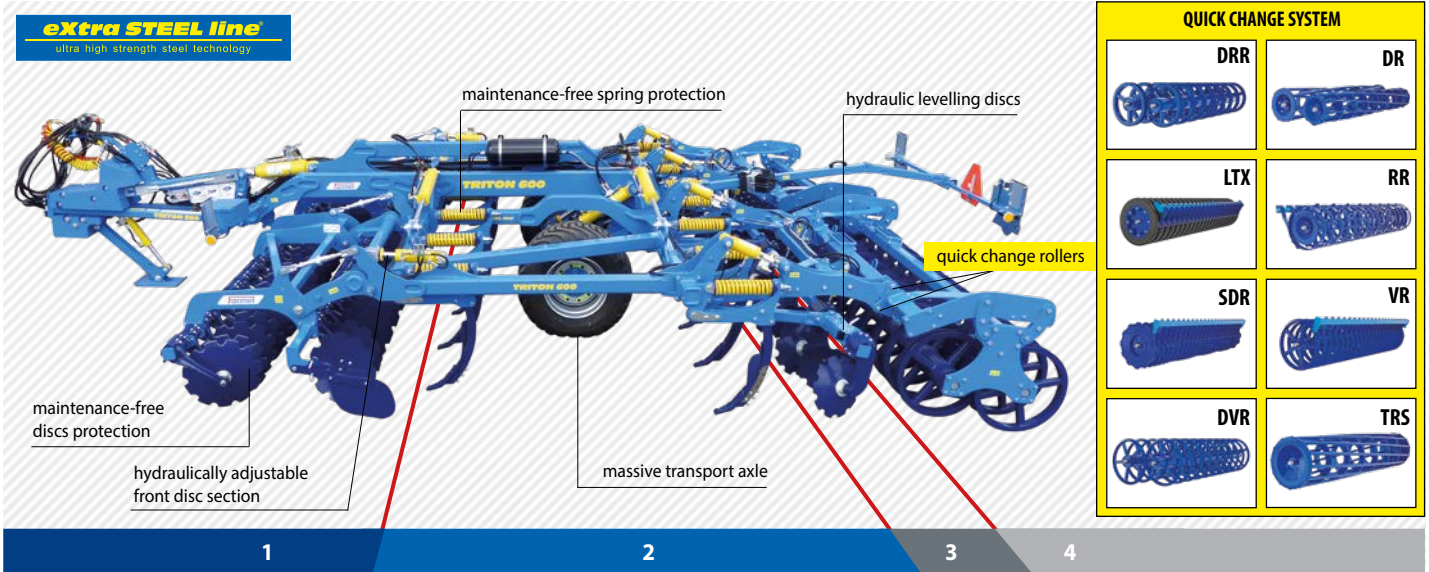

1. Discs with the diameter of 510 / 560 mm (20" / 22") arranged in two rows undercut the soil.
2. Massive tines situated in 2 rows ensure quality tillage of the soil and incorporation of crop residues. (Optional chisels, page 35).
3. Levelling discs for fine structure of the soil on surface.
4. The rear roller provides optimal re-compaction, crumbles the clods and levels off the field surface. (Optional rollers, page 41).

Option of working without the optional rollers and levelling discs.

Technical parameters	Units	Triton 300 P	Triton 450 PS	Triton 600 PS
Working width	mm / ft	2800 / 9' 2"	4500 / 14' 9"	6000 / 19' 8"
Transport width	mm / ft	3000 / 9' 10"	3000 / 9' 10"	3000 / 9' 10"
Transport height	mm / ft	1800 / 5' 11"	3370 / 11' 1"	3950 / 12' 11"
Total machine length	mm / ft	9450 / 31'	9500 / 31' 2"	9550 / 31' 4"
Working depth	mm in	30–350 3.25"–13.75"	30–350 3.25"–13.75"	30–350 3.25"–13.75"
Number of tines / discs	pcs	7 / 22	11 / 38	15 / 42
Working performance	ha/h ac/h	2.2–3.4 5.4–8.4	3.6–5.4 8.9–13.3	4.8–7.2 11.9–17.8
Towing vehicle	kW HP	150–235 200–315	210–320 290–440	335–465 460–640
Machine weight	kg / lb.	4700 / 10362	8100 / 17857	10200 / 22487

More info at www.farmet.eu

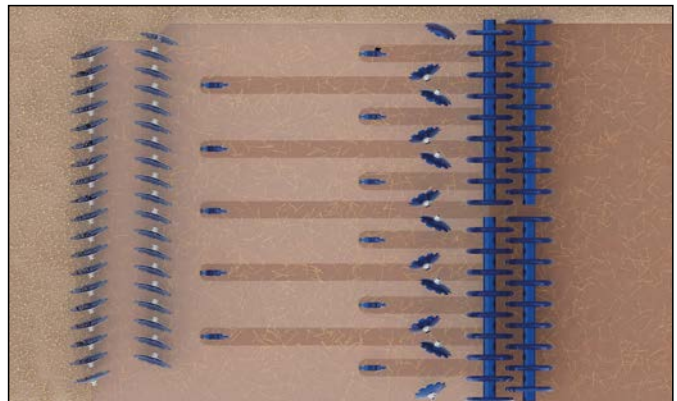

TRITON HEAVY

Full-surface soil processing with zone tillage up to the depth of 40 cm (15.75")

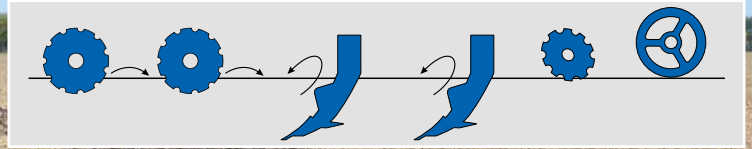

NEW

8–12 km/h
(5–8 mph)

- The combined disc-and- tine cultivator is ideal for working through heavier soils with a large quantity of crop residue. Trash is evenly mixed into the overall processed soil layer while the soil is loosened and worked by the different working elements.
- The Triton Heavy combination cultivator is equipped with two rows of discs of 620 mm / 680 mm (24.5" / 26.75") diameter with maintenance-free overload protection. The discs have a working depth of 21 cm (8.25") and have excellent crop residue mixing properties. The following two rows of heavy duty tines have a wide spacing of 42 cm (16.5") and loosen the soil up to 40 cm (15.75") depth, while allowing excellent water penetration through to the subsurface. The final row of levelling discs combined with the rear packer help to achieve a level and compacted surface.

The TRITON HEAVY combination cultivator provides the advantages of disc cultivators and tine cultivators in one pass. The result is efficient cutting and mixing of crop residue into processed soil with deeper aeration providing excellent water penetration through the soil.

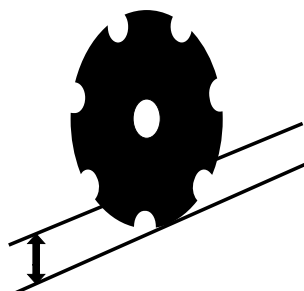

Ø 620 mm (24.5") max. 180 mm (7")
Ø 680 mm (26.75") max. 210 mm (8.25")

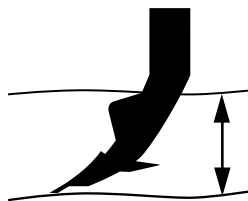

max. 400 mm (15.75")



extra STEEL line
ultra high strength steel technology

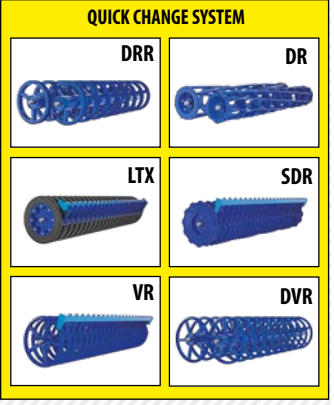
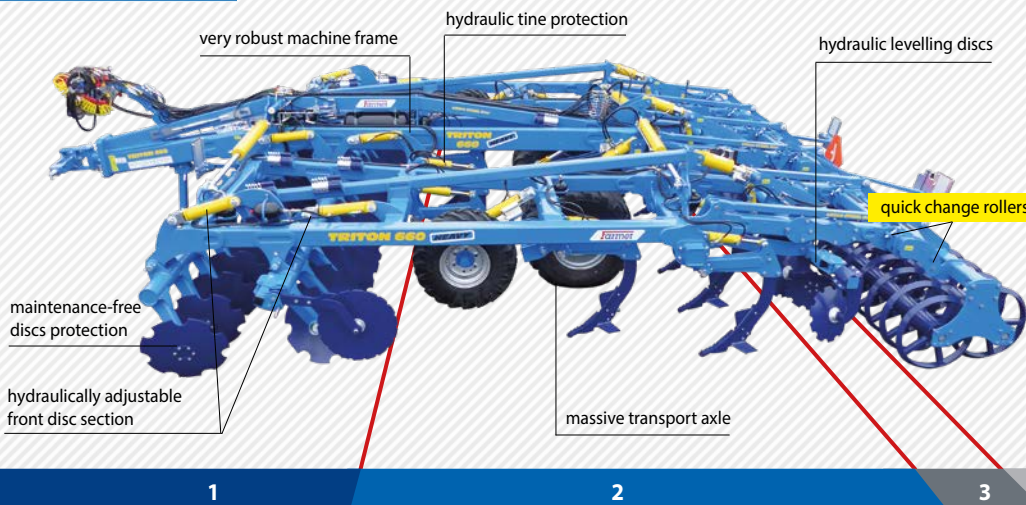

1. Discs with the diameter of 620 / 680 mm (24.5" / 26.75") arranged in two rows undercut the soil.
2. Massive tines situated in 2 rows ensure quality tillage of the soil and incorporation of crop residues. (Optional chisels, page 35).
3. Levelling discs for fine structure of the soil on surface.
4. The rear roller provides optimal re-compaction, crumbles the clods and levels off the field surface. (Optional rollers, page 41). **Option of working without the optional rollers and levelling discs.**



		NEW	NEW	NEW		
Technical parameters	Units	Triton 300 P HEAVY	Triton 410 PS HEAVY	Triton 490 PS HEAVY	Triton 580 PS HEAVY	Triton 660 PS HEAVY
Working width	mm / ft	3000 / 9' 10"	4100 / 13' 5"	4900 / 16' 1"	5800 / 19"	6600 / 21' 8"
Transport width	mm / ft	3000 / 9' 10"	3000 / 9' 10"	3000 / 9' 10"	3000 / 9' 10"	3000 / 9' 10"
Transport height	mm / ft	1950 / 6' 5"	3000 / 9' 10"	3400 / 11' 2"	3800 / 12' 6"	4000 / 13' 1"
Total machine length	mm / ft	9550 / 31' 4"	9550 / 31' 4"	9550 / 31' 4"	9550 / 31' 4"	9550 / 31' 4"
Max. discs working depth	mm / in	180 / 210 7" / 8.25"	180 / 210 7" / 8.25"	180 / 210 7" / 8.25"	180 / 210 7" / 8.25"	180 / 210 7" / 8.25"
Number of discs / chisels	pcs	14 / 7	20 / 9	24 / 11	28 / 13	32 / 15
Working performance	ha/h / ac/h	2.4-3.6 / 5.9-8.9	3.3-4.9 / 8.2-12.1	3.9-5.9 / 9.6-14.6	4.6-7.0 / 11.4-17.3	5.4-7.9 / 13.3-19.5
Max. chisels working depth	mm / in	400 / 15.75"	400 / 15.75"	400 / 15.75"	400 / 15.75"	400 / 15.75"
Towing vehicle	kW / HP	155-260 210-350	220-290 290-380	260-340 350-460	310-400 410-540	350-460 450-600
Machine weight	kg / lb.	5300 / 11684	8100 / 17857	9100 / 20062	10100 / 22266	11800 / 26014

More info at www.farmet.eu



TRIOLENT DUOLENT

Cultivator with wide scope of the working depth



TRIOLENT

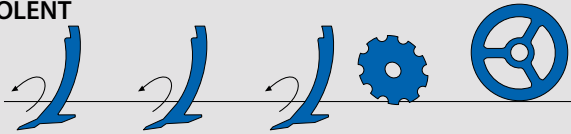

DUOLENT

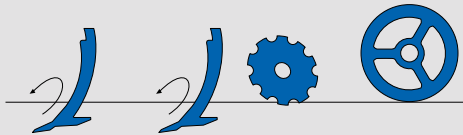

Tine cultivators Trioilent / Duolent are especially suitable for full-surface stubble-cultivation with intensive mixing effect. The soil is processed up to the depth of 35 cm (13.75") and thus can replace ploughing. Excellently incorporates crop residues into the soil.



550 kg
(1212 lb.)

NEW

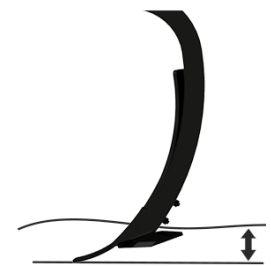

60-350 mm (2.25"-13.75")

**8-12 km/h
(5-8 mph)**



Trioilent NS



Trioilent PS



Duolent NS



Duolent PS

extra STEEL line
ultra high strength steel technology

TRIOLENT



DUOLENT N/NS



- Tine cultivator is suitable for both common stubble cultivation and tillage, and for deepening to the depth greater than usual depth of ploughing.
- Tine cultivator is equipped with three rows (Triolent), two rows (Duolent) of working units with the tine spacing of 290 mm (11.5") [420 mm (16.5")], which ensures quality tilling of the soil and incorporation of crop residues with relatively low pulling requirement. The tines are equipped with spring protection with release force of 450 kg (992 lb.) and enable to work to the depth of 35 cm (13.75"). For work to the depth of 20 cm (7.75") tines can be equipped with wings for full-surface undercut. For greater depths it works better without wings since the pulling requirement is significantly reduced. The quality of processing is not deteriorated.

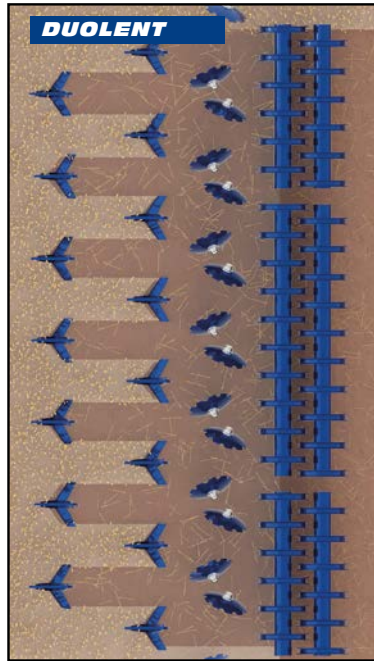
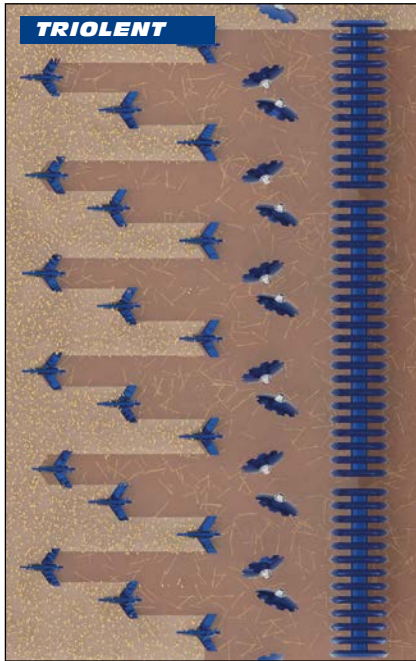

DUOLENT



DUOLENT

Version with mechanical setting the working depth

DUOLENT
NEW

Version with hydraulic setting the working depth

TRIOLENT

Version with mechanical setting the working depth

TRIOLENT
NEW

Version with hydraulic setting the working depth

Technical parameters	Units	Triolent TX 300 N	Triolent TX 350 N FIX	Triolent TX 380 NS	Triolent TX 400 N FIX	Triolent TX 470 NS
Working width	mm / ft	3000 / 9' 10"	3500 / 11' 6"	3800 / 12' 6"	4000 / 13' 1"	4700 / 15' 5"
Transport width	mm / ft	3000 / 9' 10"	3500 / 11' 6"	2300 / 7' 6"	4000 / 13' 1"	3000 / 9' 10"
Transport height	mm / ft	1400 / 4' 7"	1400 / 4' 7"	2500 / 8' 2"	1400 / 4' 7"	2500 / 8' 2"
Total machine length	mm / ft	4060 / 13' 4"	4060 / 13' 4"	4050 / 13' 4"	4050 / 13' 4"	4050 / 13' 4"
Working depth	mm / in	60-350 / 2.25"-13.75"	60-350 / 2.25"-13.75"	60-350 / 2.25"-13.75"	60-350 / 2.25"-13.75"	60-350 / 2.25"-13.75"
Number of tines	pcs	10	13	13	13	16
Working performance	ha/h / ac/h	2.4-3.6 / 5.9-8.9	2.8-4.2 / 6.9-10.4	3.1-4.5 / 7.7-11.1	3.2-4.8 / 7.9-11.9	3.7-5.6 / 9.1-13.8
Towing vehicle	kW / HP	110-165 / 150-225	120-175 / 160-240	125-190 / 170-255	125-190 / 170-255	150-220 / 200-300
Machine weight	kg / lb.	1680 / 3704	1920 / 4233	2655 / 5853	2650 / 5842	3010 / 6636

 More info at www.farmet.eu

Technical parameters	Units	Duolent DX 210 N	Duolent DX 300 N	Duolent DX 350 N FIX	Duolent DX 380 NS	Duolent DX 460 NS	Duolent DX 550 NS
Working width	mm / ft	2100 / 6' 11"	3000 / 9' 10"	3500 / 11' 6"	3800 / 12' 6"	4600 / 15' 1"	5500 / 18'
Transport width	mm / ft	2230 / 7' 4"	3000 / 9' 10"	3500 / 11' 6"	2200 / 7' 3"	3000 / 9' 10"	3000 / 9' 10"
Transport height	mm / ft	1400 / 4' 7"	1400 / 4' 7"	1400 / 4' 7"	2500 / 8' 2"	2500 / 8' 2"	2500 / 8' 2"
Total machine length	mm / ft	3350 / 10' 12"	3350 / 10' 12"	3350 / 10' 12"	3350 / 10' 12"	3350 / 10' 12"	3350 / 10' 12"
Working depth	mm / in	60-350 / 2.25"-13.75"	60-350 / 2.25"-13.75"	60-350 / 2.25"-13.75"	60-350 / 2.25"-13.75"	60-350 / 2.25"-13.75"	60-350 / 2.25"-13.75"
Number of tines	pcs	5	7	9	9	11	13
Working performance	ha/h / ac/h	1.7-2.5 / 4.2-6.2	2.4-3.6 / 5.9-8.9	2.8-4.2 / 6.9-10.4	3.1-4.5 / 7.7-11.1	3.7-5.5 / 9.1-13.6	4.4-6.6 / 10.9-16.3
Towing vehicle	kW / HP	65-110 / 90-135	90-135 / 120-180	105-160 / 140-210	120-180 / 160-240	150-225 / 200-300	180-270 / 240-360
Machine weight	kg / lb.	1060 / 2337	1375 / 3031	1585 / 3494	2220 / 4894	2515 / 5545	2870 / 6327

 More info at www.farmet.eu



- Tine cultivator is suitable for both common stubble cultivation and tillage, and for deepening to the depth greater than usual depth of ploughing.
- Tine cultivator is equipped with three rows (Triolent), two rows (Duolent) of working members with the tine spacing of 290 mm (11.5") [420 mm (16.5")], which ensures quality tilling of the soil and incorporation of crop residues with relatively **low pulling requirement**. The tines are equipped with spring protection with release force of 450 kg (992 lb.) and enable to work to the depth of 35 cm (13.75") . For work to the depth of 20 cm (7.75") tines can be equipped with wings for **full-surface undercut**. For greater depths it works better without wings since the pulling requirement is significantly reduced. The quality of processing is not deteriorated.

TILLAGE AND DEEP LOOSENING

DUOLENT



DUOLENT



Technical parameters	Units	Triolent TX 300 P	Triolent TX 400 P FIX	Triolent TX 470 PS	Triolent TX 600 PS	Triolent TX 800 PS	Triolent TX 1050 PS
Working width	mm / ft	3000 / 9' 10"	4000 / 13' 1"	4700 / 15' 5"	6200 / 20' 4"	7900 / 25' 11"	10500 / 34' 5"
Transport width	mm / ft	3000 / 9' 10"	4000 / 13' 1"	3000 / 9' 10"	3000 / 9' 10"	3000 / 9' 10"	3000 / 9' 10"
Transport height	mm / ft	1400 / 4' 7"	1400 / 4' 7"	1400 / 4' 7"	3300 / 10' 10"	4000 / 13' 1"	4000 / 13' 1"
Total machine length	mm / ft	7495 / 24' 7"	7495 / 24' 7"	7495 / 24' 7"	7495 / 24' 7"	7495 / 24' 7"	7495 / 24' 7"
Working depth	mm in	60–300 2.25"–12"	60–300 2.25"–12"	60–300 2.25"–12"	60–300 2.25"–12"	60–300 2.25"–12"	60–300 2.25"–12"
Number of tines	pcs	10	14	16	19	25	31
Tine spacing	mm / ft	300 / 12"	285 / 11"	294 / 11.5"	326 / 13"	316 / 12.5"	339 / 13.5"
Working performance	ha/h ac/h	2.4–3.6 5.9–8.9	3.2–4.8 7.9–11.9	3.8–5.6 9.4–13.8	4.8–7.2 11.9–17.8	6.4–9.6 15.8–23.7	8.4–12.6 20.8–31.1
Towing vehicle	kW HP	110–165 150–225	125–180 170–245	150–220 200–300	245–370 330–500	295–440 400–600	370–550 500–740
Machine weight	kg / lb.	3280 / 7235	4260 / 9392	4620 / 10185	6750 / 14881	7550 / 16645	11800 / 26014

More info at www.farmet.eu

TRIOLENT



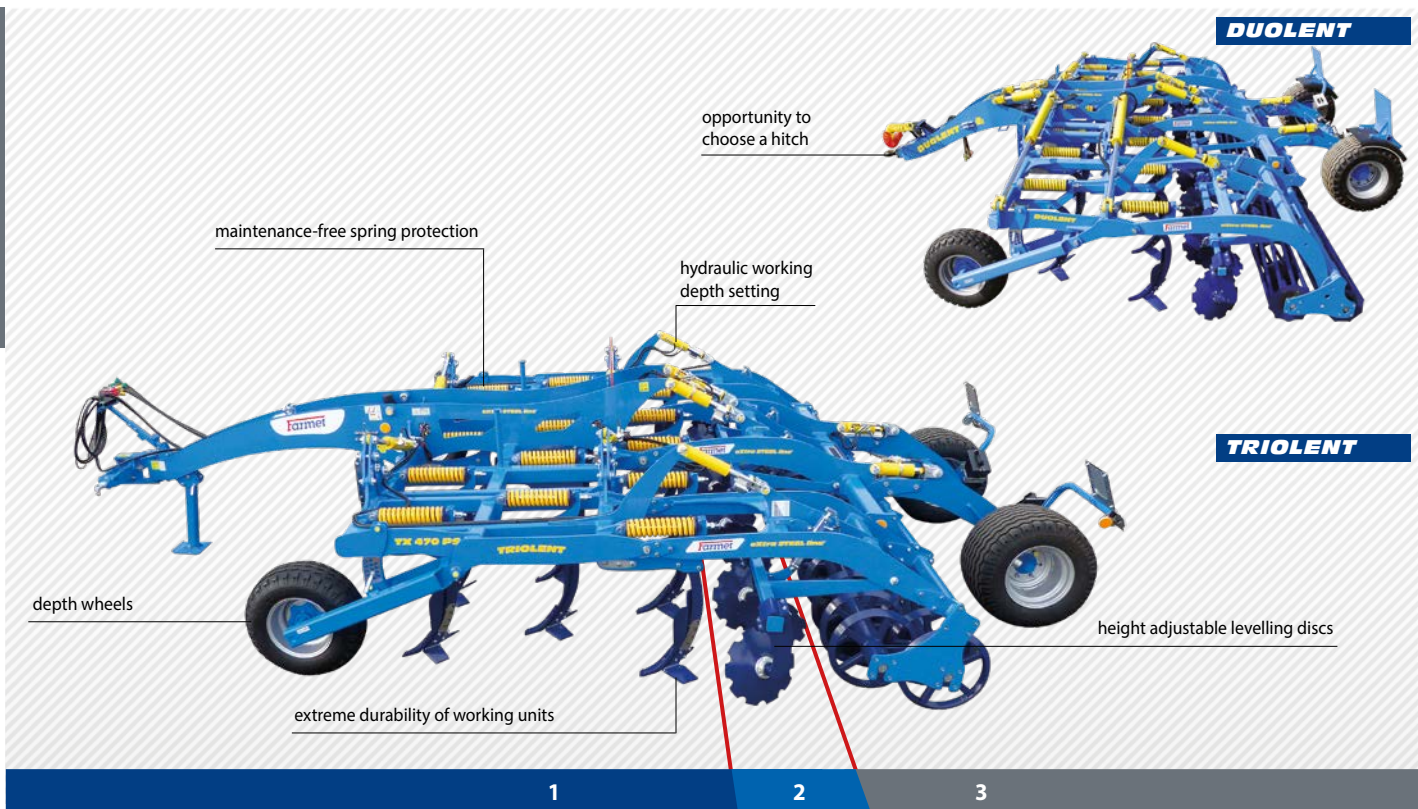

1. Massive tines situated in 3 rows (Triolent) / 2 rows (Duolent) ensure quality tillage of the soil and incorporation of crop residues. (Optional chisels, page 35).
2. Levelling discs for fine structure of the soil on surface.
3. Rear roller provides good re-compaction of the soil, crumbling of clods and levelling the surface. (Optional rollers, page 41).



NEW

NEW

NEW

Technical parameters	Units	Duolent DX 420 PSM	Duolent DX 460 PS	Duolent DX 570 PSM	Duolent DX 600 PS	Duolent DX 720 PSM	Duolent DX 800 PS
Working width	mm / ft	4200 / 13' 9"	4600 / 15' 1"	5700 / 18' 8"	6200 / 20' 4"	7200 / 23' 7"	7900 / 25' 11"
Transport width	mm / ft	3000 / 9' 10"	3000 / 9' 10"	3000 / 9' 10"	3000 / 9' 10"	3000 / 9' 10"	3000 / 9' 10"
Transport height	mm / ft	2700 / 8' 10"	2700 / 8' 10"	3050 / 10' "	3300 / 10' 10"	3750 / 12' 4"	4000 / 13' 1"
Total machine length	mm / ft	6762 / 22' 2"	6762 / 22' 2"	6762 / 22' 2"	6762 / 22' 2"	6762 / 22' 2"	6762 / 22' 2"
Working depth	mm in	60–300 2.25"–12"	60–300 2.25"–12"	60–300 2.25"–12"	60–300 2.25"–12"	60–300 2.25"–12"	60–300 2.25"–12"
Number of tines	pcs	11	11	15	15	19	19
Tine spacing	mm / ft	375 / 15"	420 / 16.5"	375 / 15"	420 / 16.5"	375 / 15"	420 / 16.5"
Working performance	ha/h ac/h	3.4–5 8.4–12.4	3.7–5.5 9.1–13.6	4.6–6.8 11.4–16.8	4.8–7.2 11.9–17.8	5.8–8.6 14.3–21.3	6.4–9.6 15.8–23.7
Towing vehicle	kW HP	150–225 200–305	150–225 200–305	220–330 300–450	220–330 300–450	265–400 360–540	265–400 360–540
Machine weight	kg / lb.	4250 / 9370	4450 / 9810	5750 / 12677	6050 / 13338	6450 / 14220	6795 / 14980

 More info at www.farmet.eu

STRIP-TILL



Strip soil tillage up to the depth of 35 cm (13.75") with fertiliser application

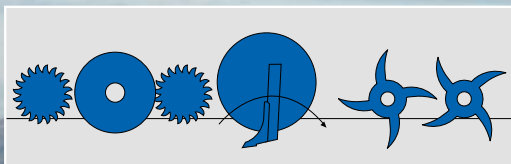

eXtra STEEL line
ultra high strength steel technology

The Strip-Till cultivator is suitable for soil tillage where soil is processed in strips with the spacing of 50 (45) cm / 1' 8" (1' 6") or 75 (70) cm / 2' 6" (2' 4") and depth of up to 35 cm (13.75") with the option to apply fertiliser at two depth levels. The strip till method is most suitable for wide-row crops as it prevents the loss of moisture from soil and has an anti-erosion effect.

Share width	206 mm (8")	Share width	25 mm (1")	Share width	40 mm (1.5")
Widia plate hardness	up to 92 HRA	Wing width	100 mm (4")	Wing width	100 mm (4")
		Widia plate hardness	up to 92 HRA	Widia plate hardness	up to 92 HRA

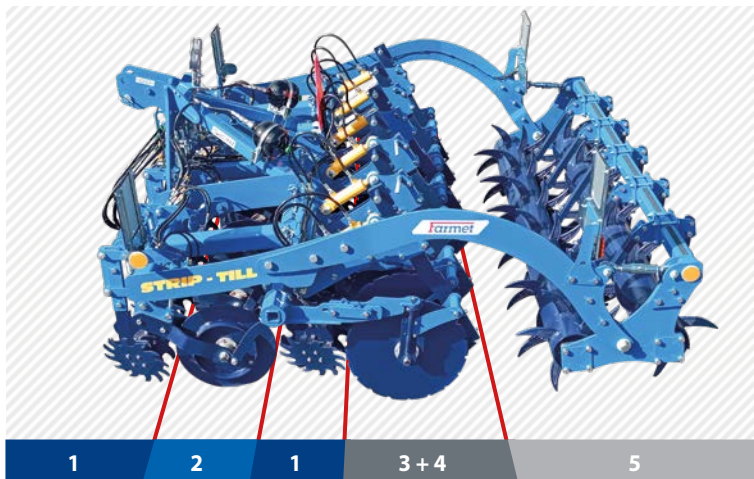

1. The row cleaner unit Ø 370 mm (14.5") places crop residue to inter rows.
2. The front disc Ø 500 mm (19.5") with the vertical angle cuts through the layer of crop residue.
3. Robust tines with hydraulic protection tills soil in a strip up to the depth of 35 cm (13.75").
4. The large side discs Ø 600 mm (23.5") form tilled strips and improve the quality of crumbling clods.
5. The double rear spiked roller crumbles clods and compacts the top layer of the tilled row.



Technical parameters	Units	Strip-Till 4	Strip-Till 6	Strip-Till 8	Strip-Till 12 FIX
Working width	mm / ft	3000 (2800) / 9' 10" (9' 2")	4500 (4200) / 14' 9" (13' 9")	6000 (5600) / 19' 8" (18' 4")	6000 (5400) / 19' 8" (17' 8")
Transport width	mm / ft	3000 (2800) / 9' 10" (9' 2")	3000 (2800) / 9' 10" (9' 2")	3000 (2800) / 9' 10" (9' 2")	6000 (5400) / 19' 8" (17' 8")
Transport height	mm / ft	2500 / 8' 2"	2600 / 8' 6"	3350 / 11' 0"	2500 / 8' 2"
Total machine length	mm / ft	3000 / 9' 10"	3050 / 10' 0"	3050 / 10' 0"	3050 / 10' 0"
Working depth	mm / in	200–350 / 7.75"–13.75"	200–350 / 7.75"–13.75"	200–350 / 7.75"–13.75"	200–350 / 7.75"–13.75"
Number of tines	pcs	4	6	8	12
Tine spacing	mm in	500 (450) / 750 (700) 1' 8" (1' 6") / 2' 6" (2' 4")	500 (450) / 750 (700) 1' 8" (1' 6") / 2' 6" (2' 4")	500 (450) / 750 (700) 1' 8" (1' 6") / 2' 6" (2' 4")	500 (450) 1' 8" (1' 6")
Working performance	ha/h ac/h	2.4–3.6 5.9–8.9	3.6–5.4 8.9–13.3	4.8–7.2 11.9–17.8	4.8–7.2 11.9–17.8
Machine weight	kg / lb.	1650 / 3638	2900 / 6393	3700 / 8157	4460 / 9832



More info at www.farmet.eu



REINFORCED CARBIDE CHISELS

CARBIDE

TILLAGE AND DEEP LOOSENING

75 MULTICARBIDE ULTRA Extra Long Life

New massive, forged chisels with an extended service life and efficient protection against wear and tear due to the strong carbide plates.

Up to 5 times longer service life

Catalog No.	VZ00013944
Chisel width	75 mm (3")
Chisel body hardness	up to 58 HRC
Carbide plate hardness	up to 92 HRA

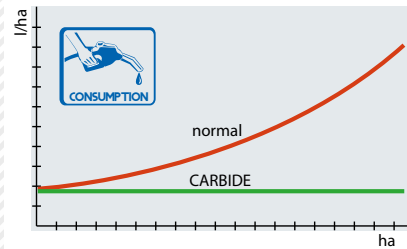

Reinforced chisel body

Massive forged chisel

Strong carbide plates

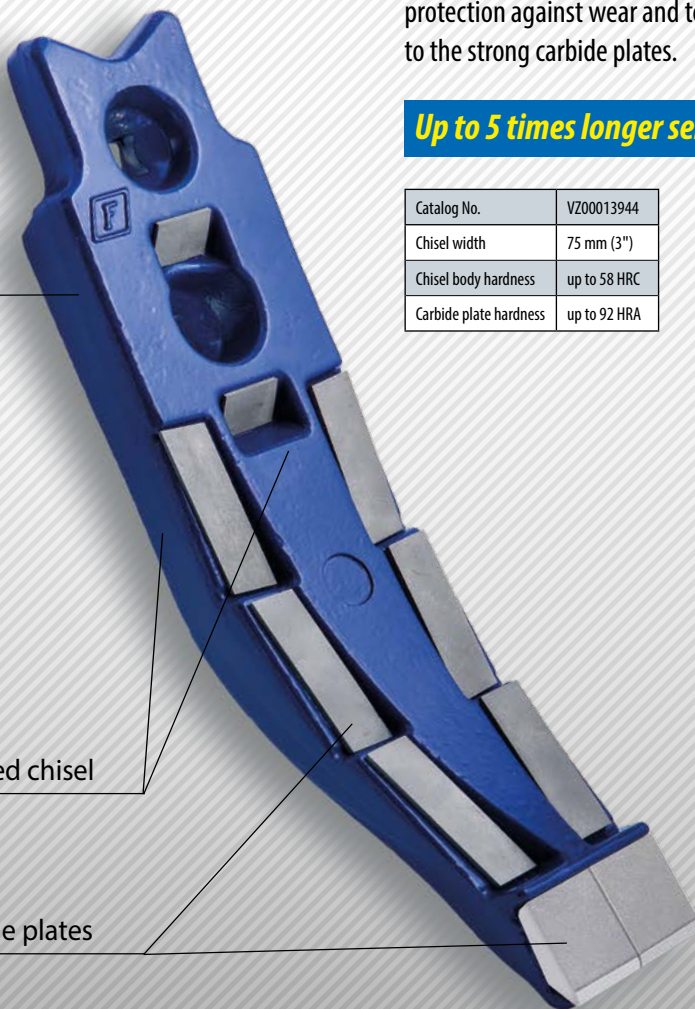

TERRIX QUATRO



TERRIX DUAL



TRITON



TRIOLENT



DUOLENT

Possibility to combine various chisels on one machine.

CARBIDE



+ 100–200 %



- 15 %

MULTICARBIDE



+ 150–400 %



- 15 %

MULTICARBIDE ULTRA



+ 200–500 %



- 15 %

Effective working depth 6–30 cm
(2.25"–11.75")

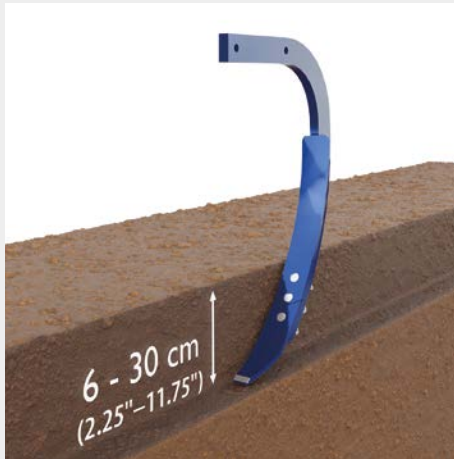

Catalog No.	4005271
Chisel width	75 mm (3")
Chisel thickness	15 mm (0.5")
Chisel body hardness	up to 55 HRC
Carbide plate hardness	up to 92 HRA

Standard



extra STEEL line
ultra high strength steel technology

75 CARBIDE

catalog No.	VZ00013778
Chisel width	75 mm (3")
Chisel body hardness	up to 58 HRC
Carbide plate hardness	up to 92 HRA

Long Life

Massive forged chisels.



extra STEEL line
ultra high strength steel technology

75 MULTICARBIDE

Catalog No.	VZ00023020
Chisel width	40 mm (1.5")
Chisel thickness	25 mm (1")
Chisel body hardness	up to 55 HRC
Carbide plate hardness	up to 92 HRA

Standard

Narrowed chisels
(40 mm / 1.5") to reduce
pulling requirement
and efficient protection
against wear and tear
due to carbide plates.

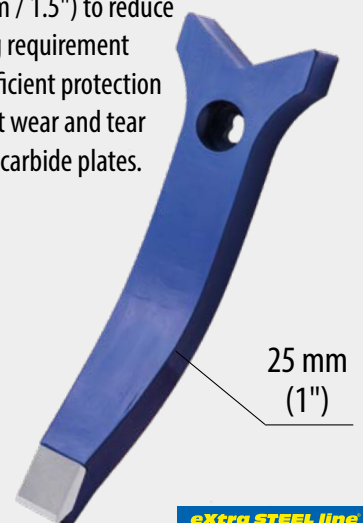

25 mm
(1")

extra STEEL line
ultra high strength steel technology

40 CARBIDE

DIGGER



Deep loosening up to the depth of 50 cm (19.5")
with intensive mixing

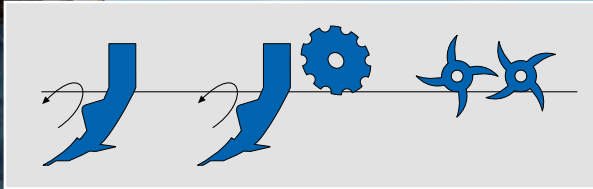

TILLAGE AND DEEP LOOSENING

eXtra STEEL line
ultra high strength steel technology

NON-MIXING TINES
NEW

MIXING TINES

Digger is suitable especially as equivalent to **standard ploughing at higher capacity and lower operating costs**. It is also suitable for deep loosening of impermeable layer of soil, levelling and fine processing of clods. It significantly improves absorption of compacted and wet soils and revitalizes headlands after harvest. It is also used for loosening of subsoil layer without risk of mixing with the biologically inactive soil.

DIGGER BASIC VERSIONS



Digger N
shear segment protection



Digger N
hydraulic protection



Digger N Fert+
front fertiliser hopper,
additional fertilisation in 2 horizons



Digger N Fert+ COMPACT
integrated fertilisation hopper,
additional fertilisation in 2 horizons



Digger P Fert+ COMPACT
drawbar and rear rubber tyred roller,
integrated fertilisation hopper,
additional fertilisation in 2 horizons



Falcon HW + Digger P Fert+
additional carrier with axle,
fertilisation hopper,
additional fertilisation in 2 horizons

8–12 km/h (5–8) mph

DIGGER

- Performs deep loosening of impermeable subsoil layer, loosening of topsoil with incorporation of crop residues and levelling together with fine processing of clods as well. The soil is ready for sowing, e.g. with sowing combination, without other operations. The processing quality **substitutes ploughing at higher performance and lower costs.**
- **Massive construction of the frame** and working units is determined for processing of soil **up to the depth of 50 cm (19.5")**. The soil processing is performed differentially according to the processing depth. Compacted subsoil layer is disintegrated and loosened without mixing with upper layers and water regime is restored. A special tine with reinforced standard and adjustable height of wings separating the depth by processing the production layer of soil with mixing from the lower part with loosening only.
- Each farmer appreciates independent **hydraulic control of working depth** for each row of the tines directly from the tractor. It is a very practical solution. In adverse weather conditions, e.g. in a wet part of the field, the operator can work only with one row. In case of congestion, the machine is simply cleared by lifting one row up.

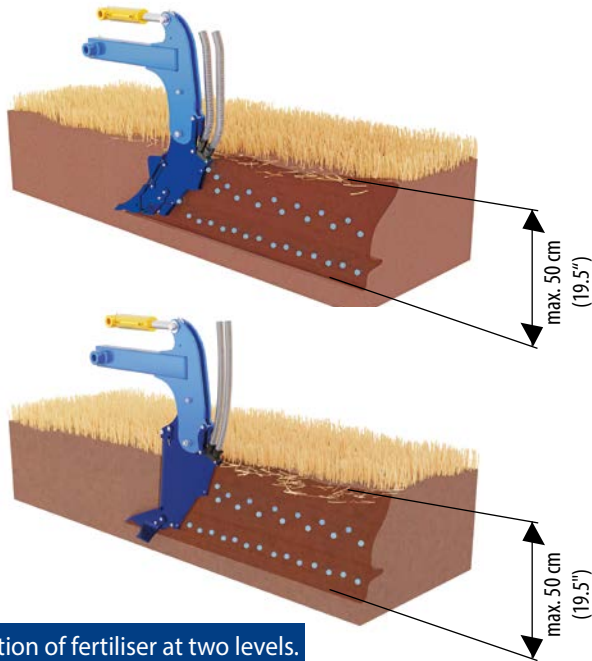

Application of fertiliser at two levels.

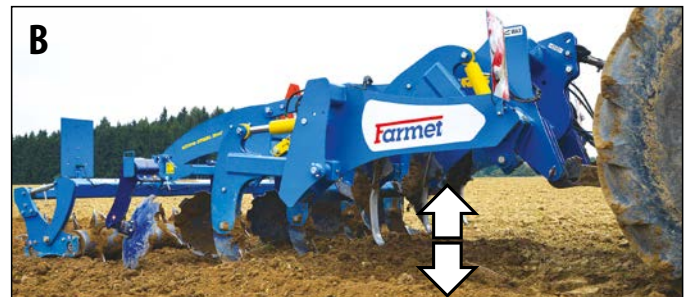

Possibility of working in a single row under difficult conditions.



Possibility of non-mixing tines.



Double ring roller DRR.



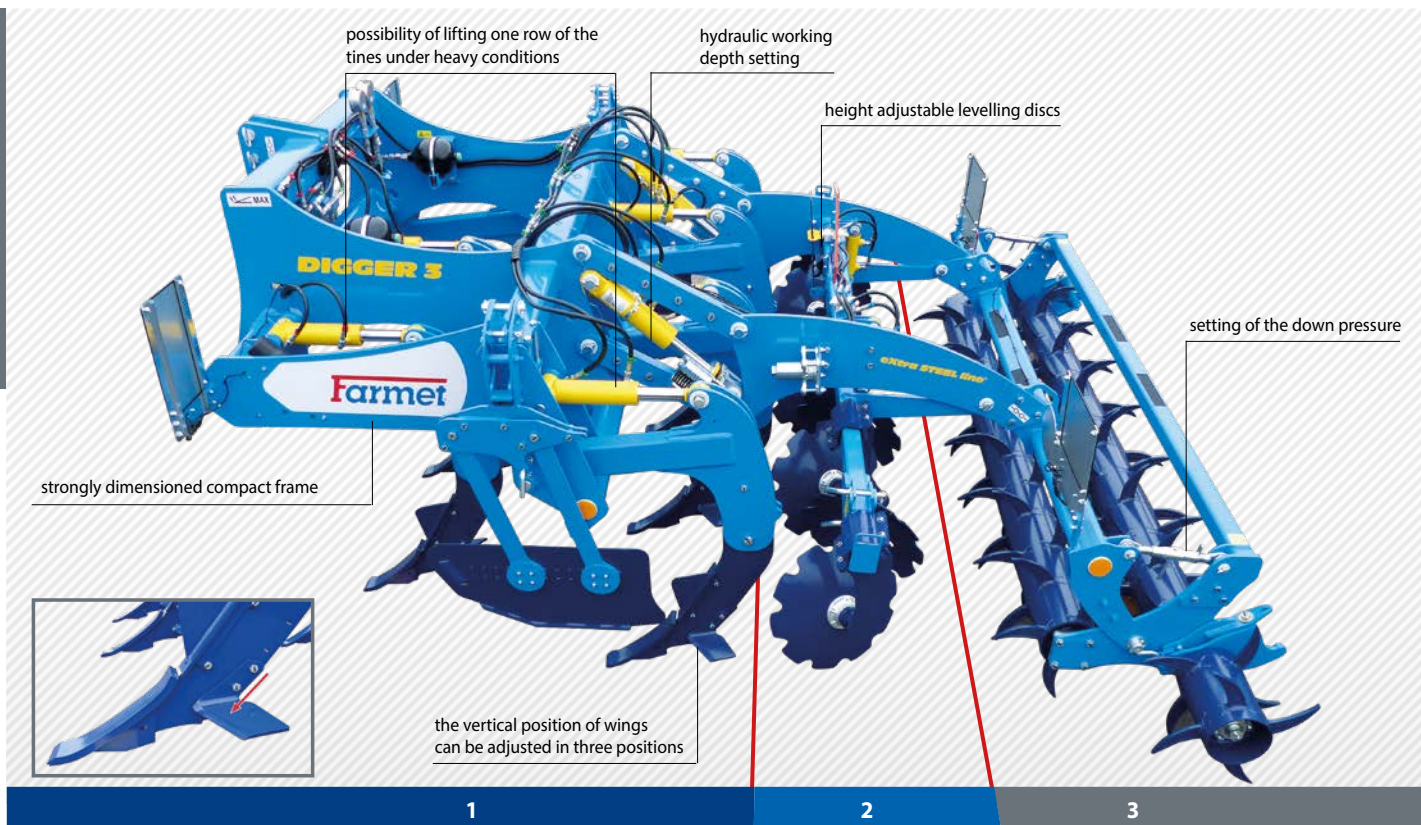

1. Massive tines arranged in 2 rows for deep loosening 25–50 cm (9.75"–19.5").
2. The levelling discs for fine structure of the soil on surface.
3. The rear double spiked roller for crumbling of clods (Page 41).

Technical parameters	Units	Digger 3 N / Digger 3 N Fert+	Digger 4 N FIX / Digger 4 N Fert+	Digger 3 N Fert+ Compact	Digger 4 N FIX Fert+ Compact	Digger 3 P Fert+ Compact	Digger 4 P FIX Fert+ Compact	Falcon HW + Digger 3 N Fert+	Falcon HW FIX + Digger 4 N Fert+
Working width	mm / ft	2900 / 9' 6"	3900 / 12' 9"	2990 / 9' 10"	3990 / 13' 1"	2990 / 9' 10"	3990 / 13' 1"	2900 / 9' 6"	3900 / 12' 9"
Transport width	mm / ft	2990 / 9' 10"	3990 / 13' 1"	2990 / 9' 10"	3990 / 13' 1"	2990 / 9' 10"	3990 / 13' 1"	2990 / 9' 10"	3990 / 13' 1"
Transport height	mm / ft	1790 / 2790 / 5' 10" / 9' 2"	1790 / 2790 / 5' 10" / 9' 2"	3500 / 11' 6"	3500 / 11' 6"	3500 / 11' 6"	3500 / 11' 6"	2790 / 9' 2"	2790 / 9' 2"
Total machine length	mm / ft	4000 / 13' 1"	4000 / 13' 1"	4125 / 13' 6"	4125 / 13' 6"	7720 / 25' 4"	7720 / 25' 4"	10980 / 36"	10980 / 36"
Working depth	mm / in	250–500 / 9.75"–19.5"	250–500 / 9.75"–19.5"	250–500 / 9.75"–19.5"	250–500 / 9.75"–19.5"	250–500 / 9.75"–19.5"	250–500 / 9.75"–19.5"	250–500 / 9.75"–19.5"	250–500 / 9.75"–19.5"
Number of tines	pcs	7	9	7	9	7	9	7	9
Working performance	ha/h / ac/h	2.4–3.6 / 5.9–8.9	3.1–4.7 / 7.7–11.6	2.4–3.6 / 5.9–8.9	3.1–4.7 / 7.7–11.6	2.4–3.6 / 5.9–8.9	3.1–4.7 / 7.7–11.6	2.4–3.6 / 5.9–8.9	3.1–4.7 / 7.7–11.6
Towing vehicle	kW / HP	180–270 / 240–360	240–360 / 330–450	180–270 / 240–360	290–435 / 400–540	220–330 / 300–450	265–400 / 360–540	220–330 / 300–450	265–400 / 360–540
Machine weight	kg / lb.	2800 / 2850 / 6173 / 6231	3700 / 3750 / 8157 / 8267	3460 / 7628	4600 / 10141	6900–7500 / 15212–16534	7900–8700 / 17416–19180	5150–5750 / 11353–12676	5850–6650 / 12897–14661

 More info at www.farmet.eu

New massive forged chisels with an extended service life and efficient protection against wear and tear due to the strong carbide plates.

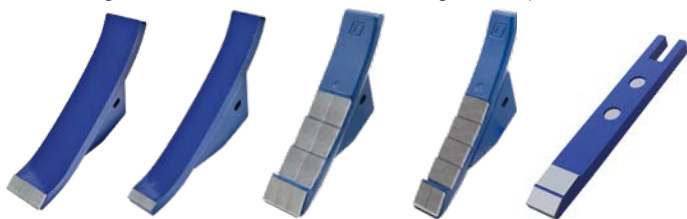

DIGGER FERT+ COMPACT

up to 2000 l (56.8 bu.)



DIGGER FERT+ & FALCON FH

FALCON FH
1600 or 2200 l
(45.4 bu. or 62.5)



Application of fertiliser at two levels.

KRTEK



Subsoiler used for deep soil loosening without mixing it with subsoil layer up to the depth of 60 cm (23.5")

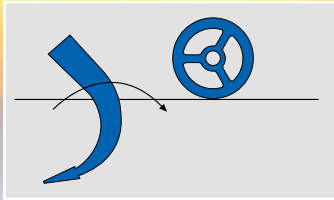

**8–12 km/h
(5–8 mph)**

eXtra STEEL line
ultra high strength steel technology

Krtek is especially suitable for deep loosening of compacted and impermeable layer of soil. It significantly improves absorption of compacted and wet soil. Loosening of subsoil layer is performed without risk of mixing of biologically inactive soil with topsoil.



1. Tines in one row for deep loosening up to the depth of 60 cm (23.5").
2. A rear roller ensures good re-compaction, clods crumbling and levelling of the land surface.

- The subsoiler is designed for work in all soil conditions which is enabled by hydraulic automatic protection.
- The time-tested tines with possibility of powerful automatic hydraulic protection or alternatively with maintenance-free fixed pull rods.
- Depth wheels for more precise deep guiding of the machine.



Technical parameters	Units	Krtek DG 3	Krtek DG 5	Krtek DG 7 FIX
Working width	mm / ft	2200 / 7' 3"	2990 / 9' 10"	4400 / 14' 5"
Transport width	mm / ft	2700 / 8' 10"	3000 / 9' 10"	4450 / 14' 7"
Transport height	mm / ft	1980 / 6' 6"	1980 / 6' 6"	1980 / 6' 6"
Total machine length	mm / ft	1330 / 4' 4"	1380 / 4' 6"	1380 / 4' 6"
Working depth	mm in	500–600 19.75"–23.5"	500–600 19.75"–23.5"	500–600 19.75"–23.5"
Nr. of tines	pcs	3	5	7
Working performance	ha/h (ac/h)	1.4–2.6 (3.5–6.4)	2–3 (4.9–7.4)	2.8–4.2 (6.9–10.4)
Towing vehicle	kW / HP	110–165 / 150–225	180–270 / 245–360	250–380 / 335–510
Machine weight	kg / lb.	880 / 1940	1170 / 2579	1750 / 3858

More info at www.farmet.eu



1	TR		TRS	
	mm in	510 20"	600 24"	
TR TRS		kg/m	90	100
		lbs./yd	217	241



2	2.1		2.2	
	mm in	400 / 300 16" / 12"	400 / 350 16" / 14"	
DR		kg/m	135	180
		lbs./yd	298	397



3	RR		
	mm in	520 20"	
RR		kg/m	160
		lbs./yd	386



4	4.1		4.2		4.3	
	mm in	500 / 500 20" / 20"	540 / 540 21" / 21"	680 / 680 27" / 27"		
DRR		kg/m	185	195	340	
		lbs./yd	446	470	820	



5	LTX		
	mm in	586 23"	
LTX		kg/m	200
		lbs./yd	482

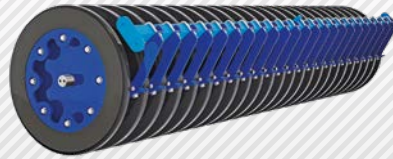

6	6.1		6.2	
	mm in	580 23"	525 21"	
SDR		kg/m	220	170
		lbs./yd	530	410



7	DFR		520 / 520 20" / 20"	
	mm in	kg/m lbs./yd	165	398
DFR		kg/m	165	398
		lbs./yd	398	



8	DSR		570 / 570 22" / 22"	
	mm in	kg/m lbs./yd	175 <th>422</th>	422
DSR		kg/m	175	422
		lbs./yd	422	



9	CR		400 16"
	mm in	kg/m lbs./yd	180 434
CR		kg/m	180
		lbs./yd	434



10	10.1		10.2	
	mm in	600 24"	550 22"	
VR		kg/m	175	160
		lbs./yd	422	386



11	11.1		11.2		11.3	
	mm in	510 / 510 20" / 20"	550 / 550 22" / 22"	680 / 680 27" / 27"		
DVR		kg/m	180	190	290	
		lbs./yd	434	458	700	



12 MICRO DRILL



		1.TR	1.TRS	2.1	2.2	3	4.1	4.2	4.3	5	6.1	6.2	7	8	9	10.1	10.2	11.1	11.2	11.3	12
Softer N, NS	✓	-	✓	✓	-	✓	-	-	-	✓	✓	-	-	-	-	✓	-	-	-	-	✓
Softer PS	4-9	-	✓	-	✓	-	-	✓	-	✓	✓	-	✓	-	-	✓	-	✓	-	-	✓
	11PS, 12PSW	-	✓	-	✓	-	-	-	-	✓	✓	-	-	-	-	✓	-	-	-	-	✓
Softer PRO	✓	-	-	-	-	-	-	✓	-	✓	✓	-	-	-	-	-	-	-	✓	-	-
Diskomat N	✓	-	✓	✓	-	✓	-	-	-	✓	✓	-	-	-	-	✓	-	-	-	-	✓
Diskomat PS	✓	-	✓	-	✓	✓	-	✓	-	✓	✓	-	-	-	-	✓	-	✓	-	-	✓
Fantom N, NS	✓	-	✓	✓	✓	✓	-	-	-	-	✓	-	✓	-	-	✓	-	-	-	-	✓
Fantom Classic	850	-	✓	-	-	-	-	✓	-	✓	✓	-	✓	-	-	✓	-	✓	-	-	✓
	1250	-	✓	-	-	-	-	-	-	✓	✓	-	✓	-	-	✓	-	✓	-	-	✓
Fantom PRO	✓	✓	-	-	-	-	✓	-	-	-	✓	✓	✓	✓	-	-	-	✓	-	-	-
Terrix PS	450-600	-	✓	-	-	-	-	-	✓	✓	✓	-	-	-	-	✓	-	-	-	✓	✓
Triton P, PS	300-600	-	✓	-	-	-	-	-	✓	✓	✓	-	-	-	-	✓	-	-	-	✓	✓
Triton Heavy	✓	-	✓	-	-	-	-	✓	-	✓	✓	-	-	-	-	✓	-	-	✓	-	-
Duolent N, NS	✓	-	✓	✓	-	✓	-	-	-	✓	✓	-	-	-	✓	✓	-	-	-	-	✓
Duolent PS	✓	-	✓	-	✓	✓	-	✓	-	✓	✓	-	-	-	-	✓	-	✓	-	-	✓
Triolent N, NS	✓	-	✓	✓	-	✓	-	-	-	✓	✓	-	-	-	✓	✓	-	-	-	-	✓
Triolent PS	✓	-	-	-	✓	✓	-	✓	-	✓	✓	-	-	-	-	✓	-	✓	-	-	✓
Digger N, P	✓	-	-	-	-	-	-	-	-	✓	-	-	✓	-	-	-	-	-	-	-	-
Falcon PRO, SW	✓	-	-	-	-	-	-	-	-	-	✓	-	-	✓	-	-	-	-	-	-	✓
Falcon COMPACT	✓	-	-	-	-	-	-	-	-	-	-	-	-	-	-	-	-	-	-	-	✓
Strip Till	✓	-	-	-	-	-	-	-	-	-	-	-	-	-	-	-	-	-	-	-	✓

KOMPAKTOMAT

Seedbed preparation of tilled soil

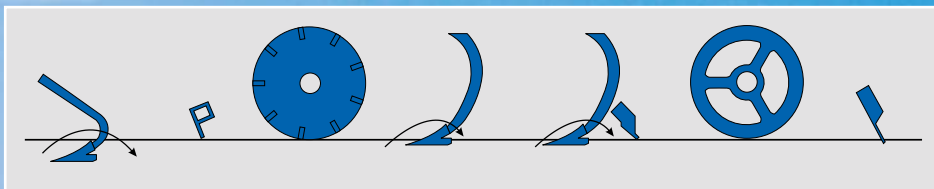

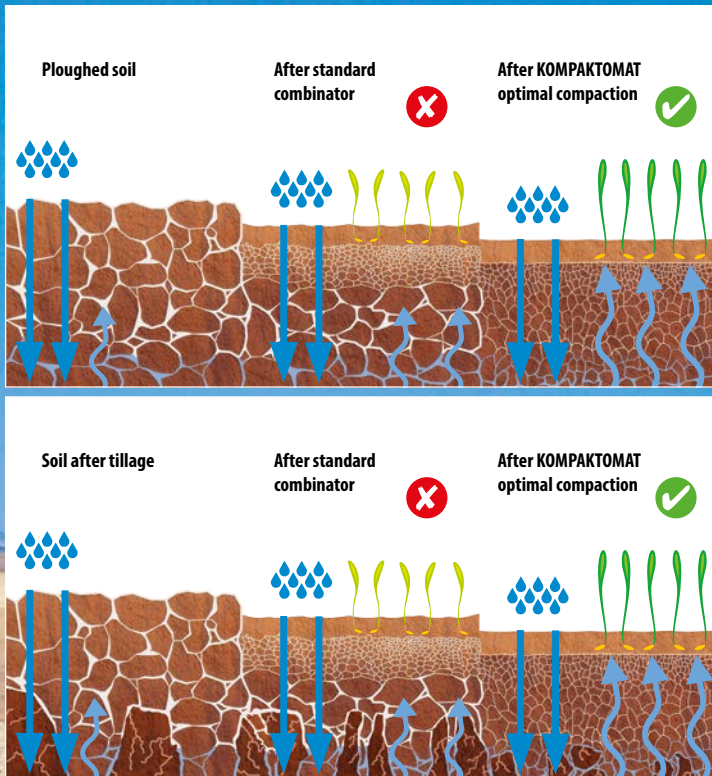

Seedbed combinator Kompaktomat are time-tested machines designed for **presowing preparation of the soil after ploughing**. During one pass the soil is perfectly processed to the state required for sowing of crops. The advantage of the machine is **excellent levelling of the surface**, fine crumbling of clods and **formation of well-compacted seedbed**. The land is perfectly levelled also due to levelling bars that can level and spread even high unevenness.

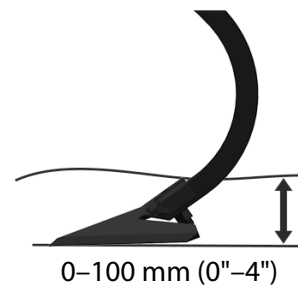

**10–14 km/h
(6–9 mph)**

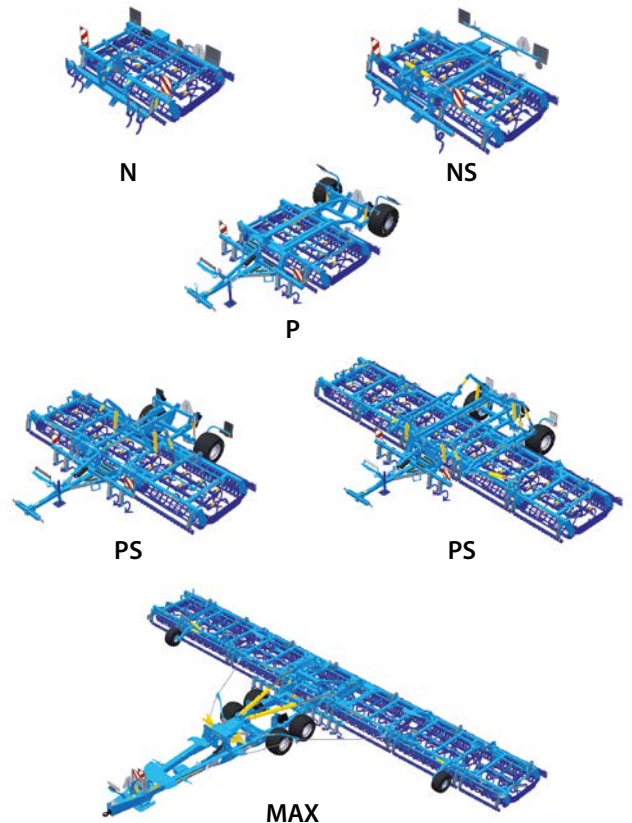

extra STEEL line
ultra high strength steel technology

KOMPAKTOMAT

- Due to **high working speed**, **high working performance** can be achieved even with lower working span of the Kompaktomat machine. Important is that due to its well-considered design and favourable weight Kompaktomat can prepare the soil after ploughing during one pass, whereas the soil is processed not only on the surface, but in the whole horizon.
- During the pass Kompaktomat performs **several working operations**, during which the surface of the soil is levelled and compacted to the depth. In the cultivated soil capillarity is restored and in the required depth the seedbed is formed. The clods are finely crumbled.
- Optionally, the combinator can be equipped with **hydraulic adjustment of depth of the share section and hydraulic adjustment of the front leveller**.

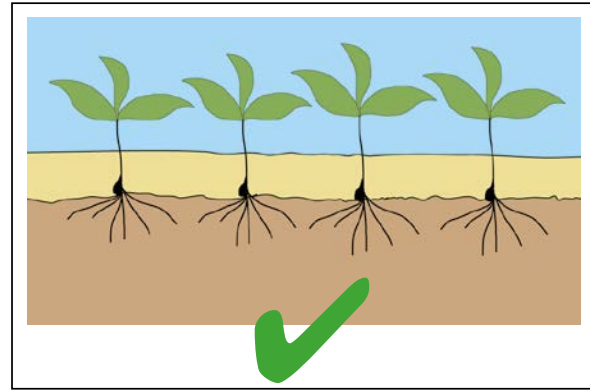
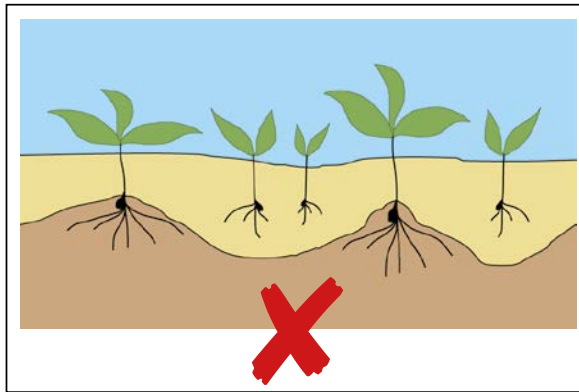

**EXAMPLES OF A THE MACHINE CONFIGURATION FOR
MORE INTENSIVE SOIL CULTIVATION
WITH LOWER THROUGHFLOW OF CROP RESIDUES**



**EXAMPLES OF THE MACHINE CONFIGURATION FOR
HIGHER THROUGHFLOW OF CROP RESIDUES**





KOMPAKTOMAT N/NS

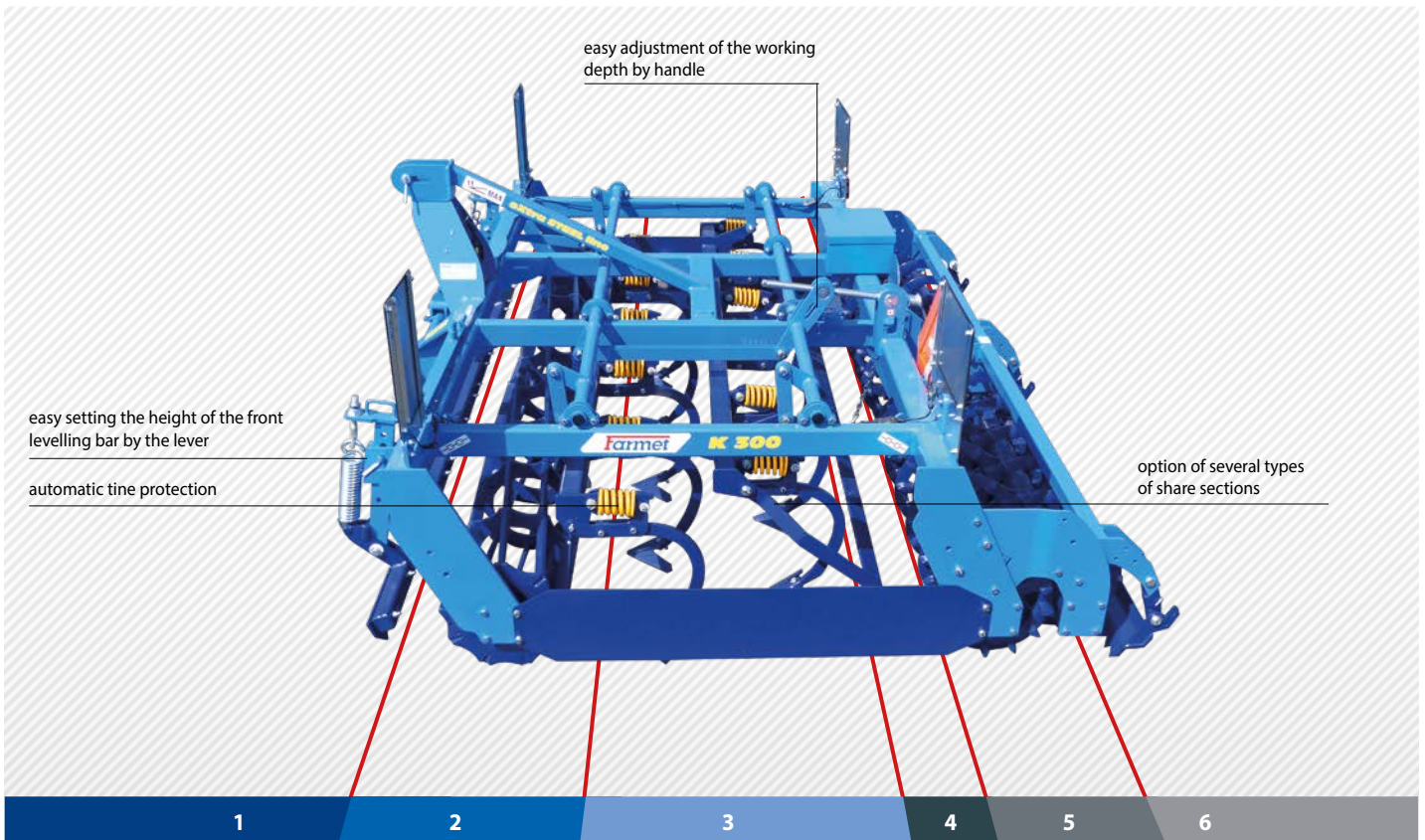

easy adjustment of the working depth by handle

easy setting the height of the front levelling bar by the lever

automatic tine protection

option of several types of share sections

1

2

3

4

5

6

1. Front scraper bar for coarse levelling of the surface.
2. Front roller for rough crumbling of clods.
3. Share working section undercuts and cultivates the soil.
4. Central levelling bar levels the cultivated soil and the soil is directed under the rear roller.
5. The rear roller for fine soil processing.
6. The rear levelling bar levels the surface.

Technical parameters	Units	Kompaktomat K 250 N	Kompaktomat K 300 N	Kompaktomat K 400 NS	Kompaktomat K 500 NS	Kompaktomat K 600 NS
Working width	mm / ft	2580 / 8' 6"	3000 / 9' 10"	4000 / 13' 1"	5000 / 16' 5"	6000 / 19' 8"
Transport width	mm / ft	2580 / 8' 6"	3000 / 9' 10"	3000 / 9' 10"	3000 / 9' 10"	3000 / 9' 10"
Total machine length	mm / ft	2640 / 8' 8"	2640 / 8' 8"	2930 / 9' 7"	3200 / 10' 6"	3200 / 10' 6"
Working depth	mm / in	0–100 / 0"–4"	0–100 / 0"–4"	0–100 / 0"–4"	0–100 / 0"–4"	0–100 / 0"–4"
Number of tines AL/CF/AP	pcs	11 / 26 / 11	13 / 30 / 12	18 / 39 / 16	23 / 49 / 23	27 / 59 / 24
Working performance	ha/h (ac/h)	2.0–3.0 (4.9–7.4)	2.2–3.2 (5.4–7.9)	3.0–4.0 (7.4–9.9)	5.0–6.0 (12.4–14.8)	6.0–7.2 (14.8–17.8)
Towing vehicle	kW / HP	55 / 75	70 / 95	90 / 125	120 / 165	130 / 180
Machine weight	kg / lb.	1155 / 2546	1510 / 3329	2670 / 5886	3150 / 6944	3500 / 7716



More info at www.farmet.eu



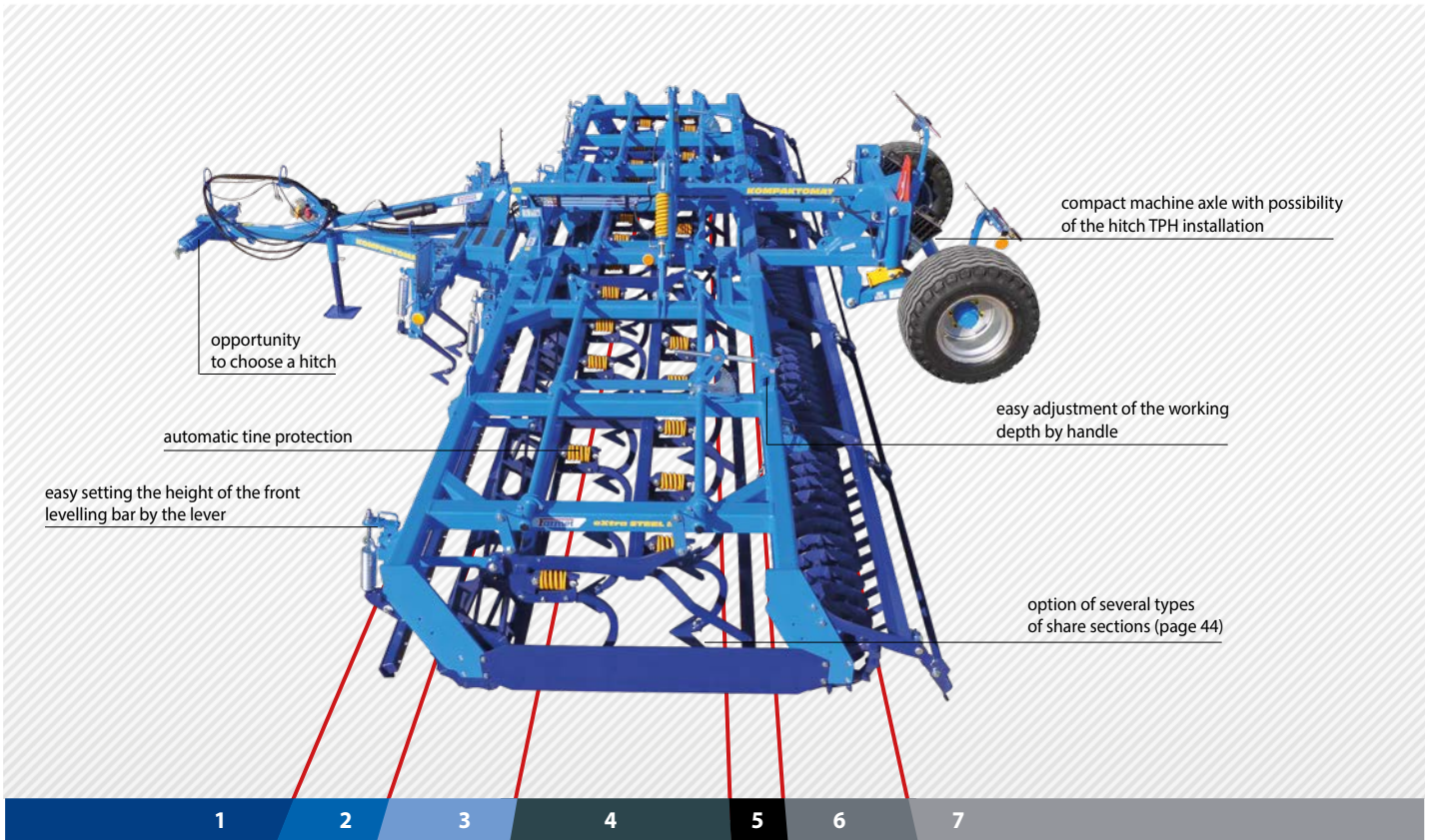

1. Track cultivators for lifting of the compacted soil.
2. Front scraper bar for coarse levelling of the surface.
3. Front roller for rough crumbling of clods.
4. Share working section undercuts and cultivates the soil.
5. Central levelling bar levels the cultivated soil and the soil is directed under the rear roller.
6. The rear roller for fine soil processing.
7. The rear levelling bar levels the surface.

Technical parameters	Units	Kompaktomat K 300 P	Kompaktomat K 400 PS	Kompaktomat K 450 PS	Kompaktomat K 500 PS	Kompaktomat K 600 PS	Kompaktomat K 700 PS	Kompaktomat K 800 PS	Kompaktomat K 1000 PS
Working width	mm / ft	3000 / 9' 10"	4000 / 13' 1"	4500 / 14' 9"	5000 / 16' 5"	6000 / 19' 8"	7000 / 22' 11"	8000 / 26' 3"	9850 / 32' 4"
Transport width	mm / ft	3000 / 9' 10"	3000 / 9' 10"	3000 / 9' 10"	3000 / 9' 10"	3000 / 9' 10"	3000 / 9' 10"	3000 / 9' 10"	3000 / 9' 10"
Transport height	mm / ft	1650 / 5' 5"	2670 / 8' 9"	3030 / 9' 11"	2790 / 9' 2"	3230 / 10' 7"	3830 / 12' 7"	4000 / 13' 1"	4000 / 13' 1"
Total machine length	mm / ft	5965 / 19' 7"	5965 / 19' 7"	5965 / 19' 7"	6105 / 20"	6105 / 20"	6105 / 20"	6105 / 20"	6660 / 21' 10"
Working depth	mm / in	0-100 / 0"-4"	0-100 / 0"-4"	0-100 / 0"-4"	0-100 / 0"-4"	0-100 / 0"-4"	0-100 / 0"-4"	0-100 / 0"-4"	0-100 / 0"-4"
Number of tines AL/CF/AP	pcs	13 / 30 / 12	18 / 39 / 16	20 / 47 / 20	23 / 49 / 23	27 / 59 / 24	31 / 69 / 31	35 / 77 / 32	43 / 91 / 38
Working performance	ha/h (ac/h)	2.2-3.2 (5.4-7.9)	3.0-4.0 (7.4-9.9)	3.5-4.5 (8.6-11.1)	3.0-5.0 (7.4-12.4)	3.5-6.0 (8.6-14.8)	4.5-7.0 (11.1-17.3)	5.5-8.0 (13.6-19.8)	8.5-10.0 (21-24.7)
Towing vehicle	kW / HP	70 / 95	90 / 125	110 / 150	120 / 165	130 / 180	150 / 205	160 / 220	180 / 245
Machine weight	kg / lb.	2360 / 5203	3010 / 6636	3340 / 7363	4025 / 8873	4360 / 9612	4960 / 10935	5345 / 11784	6920 / 15256

More info at www.farmet.eu



KOMPAKTOMAT PS LONG

NEW

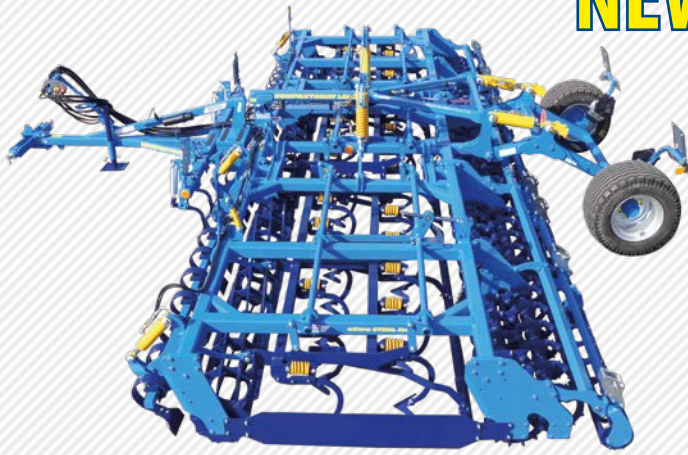

+ 25 cm (10")



Technical parameters	Units	Kompaktomat K 500 PS / LONG	Kompaktomat K 600 PS / LONG	Kompaktomat K 700 PS / LONG	Kompaktomat K 800 PS / LONG	Kompaktomat K 1000 PS / LONG
Working width	mm / ft	5000 / 16' 5"	6000 / 19' 8"	7000 / 22' 11"	8000 / 26' 3"	10000 / 32' 9"
Transport width	mm / ft	3000 / 9' 10"	3000 / 9' 10"	3000 / 9' 10"	3000 / 9' 10"	3000 / 9' 10"
Transport height	mm / ft	2790 / 9' 2"	3230 / 10' 7"	3830 / 12' 7"	4000 / 13' 1"	4000 / 13' 1"
Total machine length	mm / ft	6355 / 20" 10"	6355 / 20" 10"	6355 / 20" 10"	6355 / 20" 10"	6910 / 22' 8"
Working depth	mm / in	0-100 / 0"-4"	0-100 / 0"-4"	0-100 / 0"-4"	0-100 / 0"-4"	0-100 / 0"-4"
Number of tines AL/CF/AP/AL4	pcs	23 / 49 / 23 / 41	27 / 59 / 24 / 47	31 / 69 / 31 / 55	35 / 77 / 32 / 61	43 / 91 / 38 / 76
Working performance	ha/h ac/h	3.0-5.0 7.4-12.4	3.5-6.0 8.6-14.8	4.5-7.0 11.1-17.3	5.5-8.0 13.6-19.8	8.5-10.0 21-24.7
Towing vehicle	kW / HP	120 / 165	130 / 180	150 / 205	160 / 220	180 / 245
Machine weight	kg / lb.	4125 / 9094	4460 / 9832	5110 / 11265	5495 / 12114	7420 / 16358



More info at www.farmet.eu



Soils with crop residues



Stony soils



Heavy moist soils



KOMPAKTOMAT PS

T2
T3
T4

C40
C50
C70
K80

HT

MCD
MCD3
(K1000)

HD

HDS

T2, T3

HC

BM
BM1

> 4m

XXL

CA2
CA4
CA6
CA8

CC2
CC4
CC6
CC8

AB
AB3
ABF

NB
NB3
NBF

HB
HB3

FL
FLR
FH
FHR

L
LR
FB
FBR

BR

SB

RR

AL

CF

AP

PSL

PSD

CR	LF	RF/RFC
DCR	LF	
BR	LF	RF/RFC
SB	LF	RF/RFC
RR	LF	RF/RFC

KOMPAKTOMAT PS LONG

T2
T3
T4

C40
C50
C70
K80

CA2
CA4
CA6
CA8

CC2
CC4
CC6
CC8

MCD

HD

HDS

AB
AB3
ABF

NB
NB3
NBF

HB
HB3

T2, T3

HC

BM
BM1

> 4m

XXL

HT

FL
FLR
FH
FHR

L
LR
FB
FBR

BR

SB

RR

AL-L

CF-L

AP-L

AL4

PSL

PSD

+25 cm

FRL

CR	LF	RF/RFC
DCR	LF	RF/RFC
BR	LF	RF/RFC
SB	LF	RF/RFC
RR	LF	RF/RFC
CR+CR	LF	RF/RFC
SB+CR	LF	RF/RFC
DCRL	LF	RF/RFC

KOMPAKTOMAT MAX

KOMPAKTOMAT MAX LONG

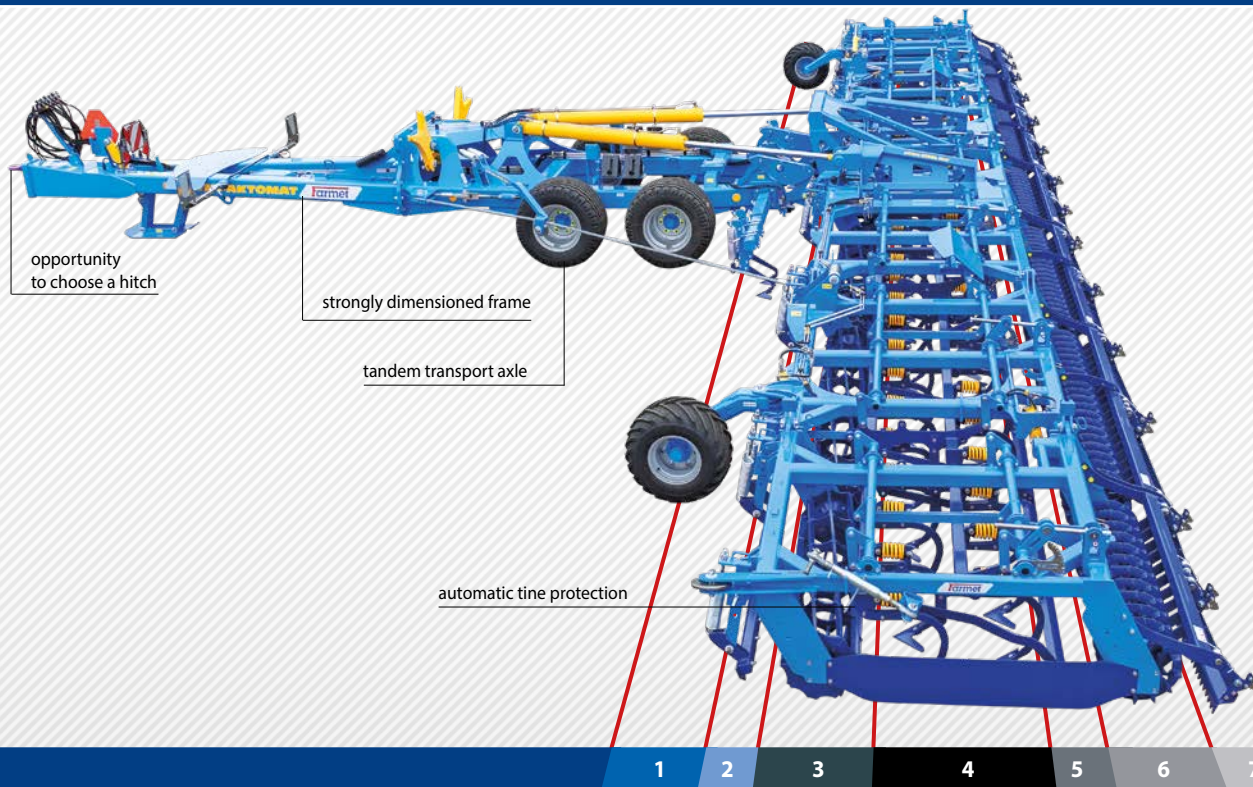

opportunity to choose a hitch

strongly dimensioned frame

tandem transport axle

automatic tine protection

1 2 3 4 5 6 7

1. Track cultivators for lifting of the compacted soil.
2. Front scraper bar for coarse levelling of the surface.
3. Front roller for rough crumbling of clods.
4. Share working section undercuts and cultivates the soil.
5. Central levelling bar levels the cultivated soil and the soil is directed under the rear roller.
6. The rear roller for fine soil processing.
7. The rear levelling bar levels the surface.

Technical parameters	Units	Kompaktomat K 1250 MAX	Kompaktomat K 1250 MAX LONG	Kompaktomat K 1570 MAX	Kompaktomat K 1570 MAX LONG
Working width	mm / ft	12500 / 41'	12500 / 41'	15700 / 51' 6"	15700 / 51' 6"
Transport width	mm / ft	3000 / 9' 10"	3000 / 9' 10"	3000 / 9' 10"	3000 / 9' 10"
Transport height	mm / ft	3500 / 11' 6"	3500 / 11' 6"	3500 / 11' 6"	3500 / 11' 6"
Total machine length	mm / ft	9550 / 31' 4"	9800 / 32' 2"	9550 / 31' 4"	9800 / 32' 2"
Working depth	mm / in	0–100 / 0"–4"	0–100 / 0"–4"	0–100 / 0"–4"	0–100 / 0"–4"
Number of tines AL/CF/AP/AL4	pcs	53 / 119 / 53 / –	53 / 119 / 53 / 95	67 / 149 / 67 / –	67 / 149 / 67 / 118
Working performance	ha/h ac/h	12.0–15.0 30–37	12.0–15.0 30–37	13.0–20.0 32–49	13.0–20.0 32–49
Towing vehicle	kW / HP	243 / 330	243 / 330	316 / 430	316 / 430
Machine weight	kg / lb.	10500 / 23148	11200 / 24691	12500 / 27557	13500 / 29762

More info at www.farmet.eu



KOMPAKTOMAT MAX

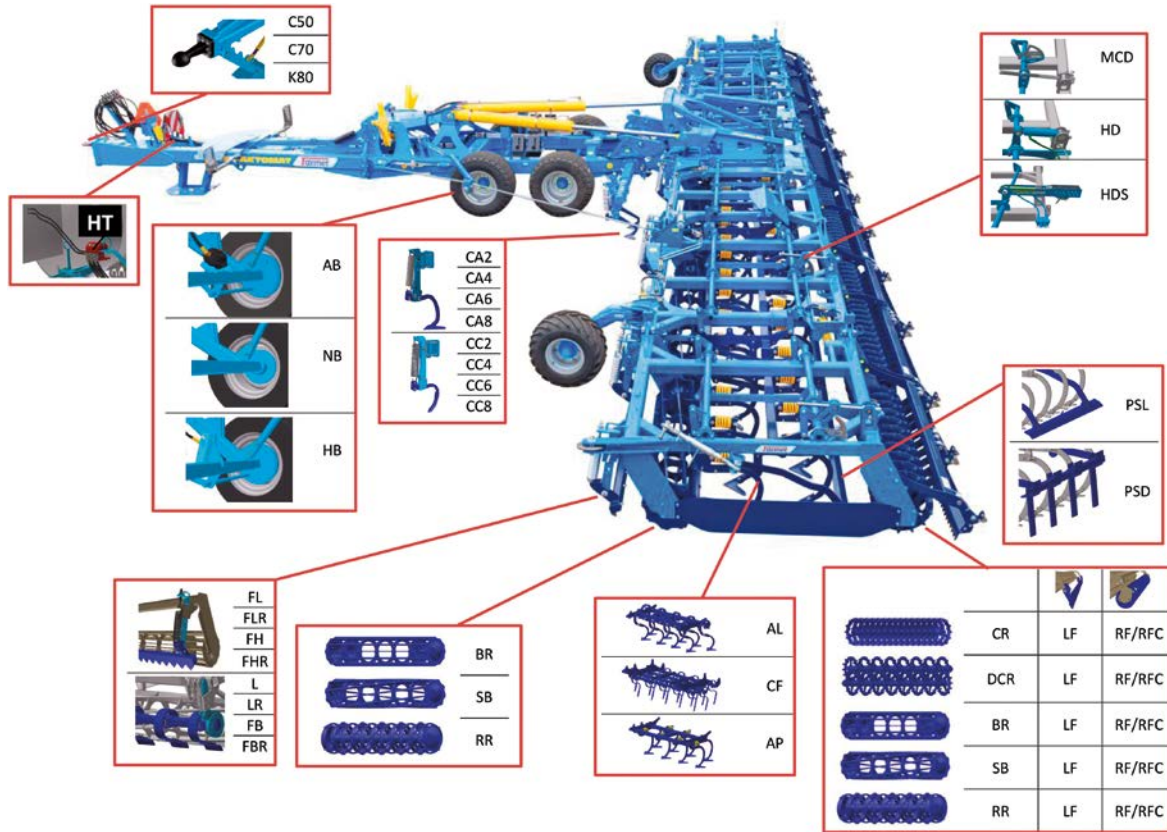

KOMPAKTOMAT MAX LONG

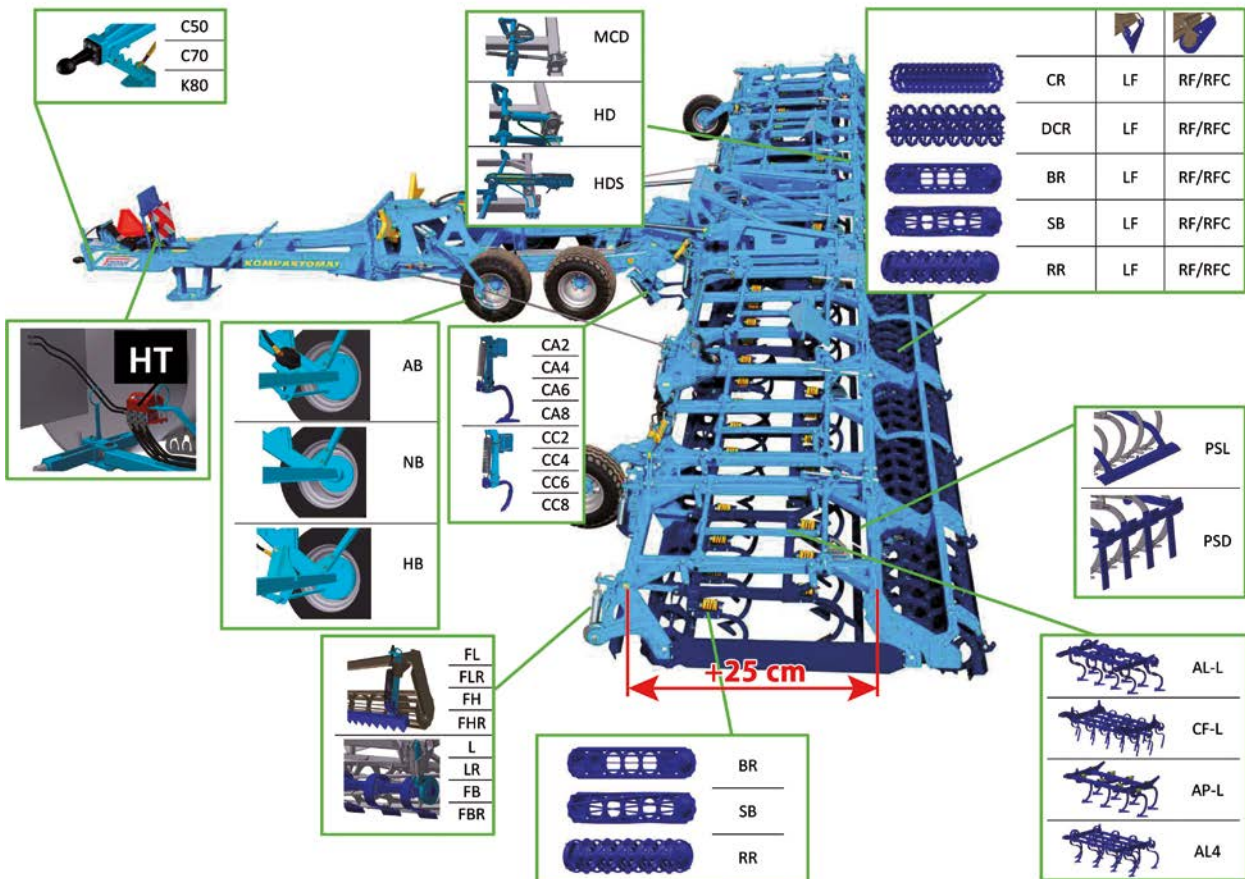

CRUMBLING ROLLERS

Extra compaction and soil crumbling
in the most difficult conditions



10–14 km/h
6–9 mph

Crumbling rollers are especially suitable for improvement of the soil processing with Kompaktomat. They are used mainly in heavy soils, in summer and autumn seasons. They effectively crumble clods.

extra STEEL line®
ultra high strength steel technology

Technical parameters	Units	DV 300 N	DV 400 NS	DV 450 NS	DV 500 NS	DV 600 NS	DV 700 NS	DV 800 NS	DV 1000 NS
Working width	mm / ft	3000 / 9' 10"	4000 / 13' 1"	4500 / 14' 9"	5000 / 16' 5"	6000 / 19' 8"	7000 / 22' 11"	8000 / 26' 3"	9850 / 32' 4"
Transport width	mm / ft	3000 / 9' 10"	3000 / 9' 10"	3000 / 9' 10"	3000 / 9' 10"	3000 / 9' 10"	3000 / 9' 10"	3000 / 9' 10"	3000 / 9' 10"
Transport height	mm / ft	1045 / 3' 5"	1650 / 5' 5"	1890 / 6' 2"	2130 / 7"	2610 / 8' 7"	3090 / 10' 2"	3565 / 11' 8"	3755 / 12' 4"
Total machine length	mm / ft	1500 / 4' 11"	1500 / 4' 11"	1500 / 4' 11"	1500 / 4' 11"	1500 / 4' 11"	1500 / 4' 11"	1500 / 4' 11"	2200 / 7' 3"
Number of wheels	pcs	24	34	40	44	52	60	68	81
Working performance	ha/h (ac/h)	2.2–3.2 (5.4–7.9)	3.0–4.0 (7.4–9.9)	3.5–4.5 (8.6–11.1)	3.0–5.0 (7.4–12.4)	3.5–6.0 (8.6–14.8)	4.5–7.0 (11.1–17.3)	5.5–8.0 (13.6–19.8)	8.5–10.0 (21.0–24.7)
Towing vehicle	kW / HP	15 / 20	20 / 27	23 / 31	25 / 34	30 / 39	35 / 46	40 / 52	50 / 65
Machine weight	kg / lb.	560 / 1235	1055 / 2326	1135 / 2502	1255 / 2767	1400 / 3086	1600 / 3527	1760 / 3880	2550 / 5622

More info at www.farmet.eu



1

1. Fine pre-sowing soil processing – crushing of clods by rolling.

- Additional crumbling crosskill rollers aggregated to the rear hitch TPH of the presowing combinator Kompaktomat are in widespread use for more intensive processing of the soil, especially heavy soil.
- During transportation the rollers are carried and therefore manoeuvrability of the machine is not reduced at all.
- The advantage of this machine is its multipurposeness bringing high variability of work.



N



NS

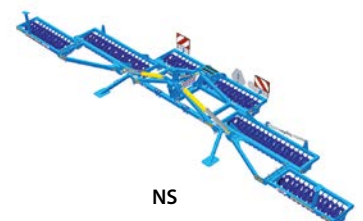

NS

CAMBRIDGE

Optimal soil compaction for excellent growth emergence



Cambridge rollers are especially suitable for **additional pre-sowing soil processing, restoration of soil capillarity, crumbling of clods and surface levelling**. They are also suitable for the soil processing after sowing – more uniform seed emergence and acceleration of vegetation. Version with knife rollers is used for effective stubble and crop residues cutting – that is achieved acceleration of their decomposition and support of volunteer growth.

**8–15 km/h
(5–9 mph)**

PRESOWING PREPARATION



1

1. Fine after-sowing soil processing – crumbling of clods by rolling.

VERSION WITH CAST-IRON ROLLERS



VERSION WITH KNIFE ROLLERS



Technical parameters	Units	Cambridge CV 6	Cambridge CV 9
Working width	mm / ft	6000 / 19' 8"	9000 / 29' 6"
Transport width	mm / ft	2400 / 7' 10"	2400 / 7' 10"
Transport height	mm / ft	1600 / 5' 3"	1600 / 5' 3"
Total machine length	mm / ft	4100 / 13' 5"	6800 / 22' 4"
Number of segments (smooth/serrated)	pcs	58 / 55	88 / 83
Working performance	ha/h (ac/h)	6.0 (14.8)	9.0 (22.2)
Towing vehicle	kW / HP	75 / 100	90 / 125
Machine weight	kg / lb.	2700 / 5952	3600 / 7937

More info at www.farmet.eu

eXtra STEEL line
ultra high strength steel technology

VERSO



Aeration, cultivation and levelling of compacted wet, heavy soil after ploughing or tillage

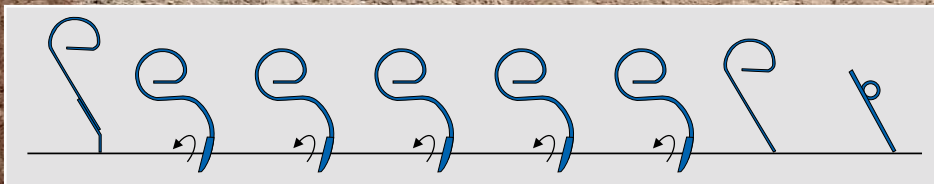



Tine harrow Verso is especially suitable for **pre-sowing preparation of the soil after ploughing or stubble-cultivation**. It levels the soil surface and prepares the seedbed.

It also ensures **excellent throughflow under heavier and wet conditions**. It is resistant to rolling up and clogging with a high levelling effect. It is also suitable for very early spring soil processing after winter or for autumn works. It ensures shallow cultivation with incorporation of crop residues and destruction of weeds. It is equipped with chisels with carbide plates.

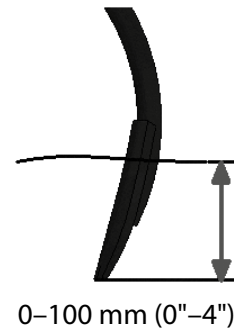

0-100 mm (0"-4")

**8-15 km/h
(5-9 mph)**

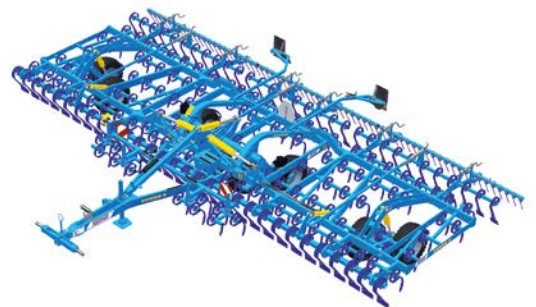
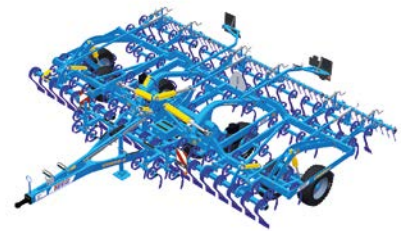

eXtra STEEL line®
ultra high strength steel technology

VERSO PS

- Tine harrow Verso is especially suitable for pre-sowing preparation of the soil after ploughing or stubble-cultivation – levelling of the surface and preparation of the seedbed.
- Verso is a semi-mounted 5-row cultivator with low pulling requirement and variable cultivating depth from 0 to 10 cm (0–4"). Semi-flexible tines with chisels of the width of 37 mm (1.5") ensure intensive and fine soil processing. The tines are flexibly fixed to the frame in the distance of 58 cm (1' 11") with the possibility of deflection in case of an impact on an obstacle.
- A great advantage of the cultivator is its excellent throughflow and resistance to clogging. When in operation, the cultivator is carried by integrated travel wheels that allow the operating staff to smoothly regulate the working depth according to the current soil conditions and thus prevent potential clogging of the machine, e.g. by lifting it up.



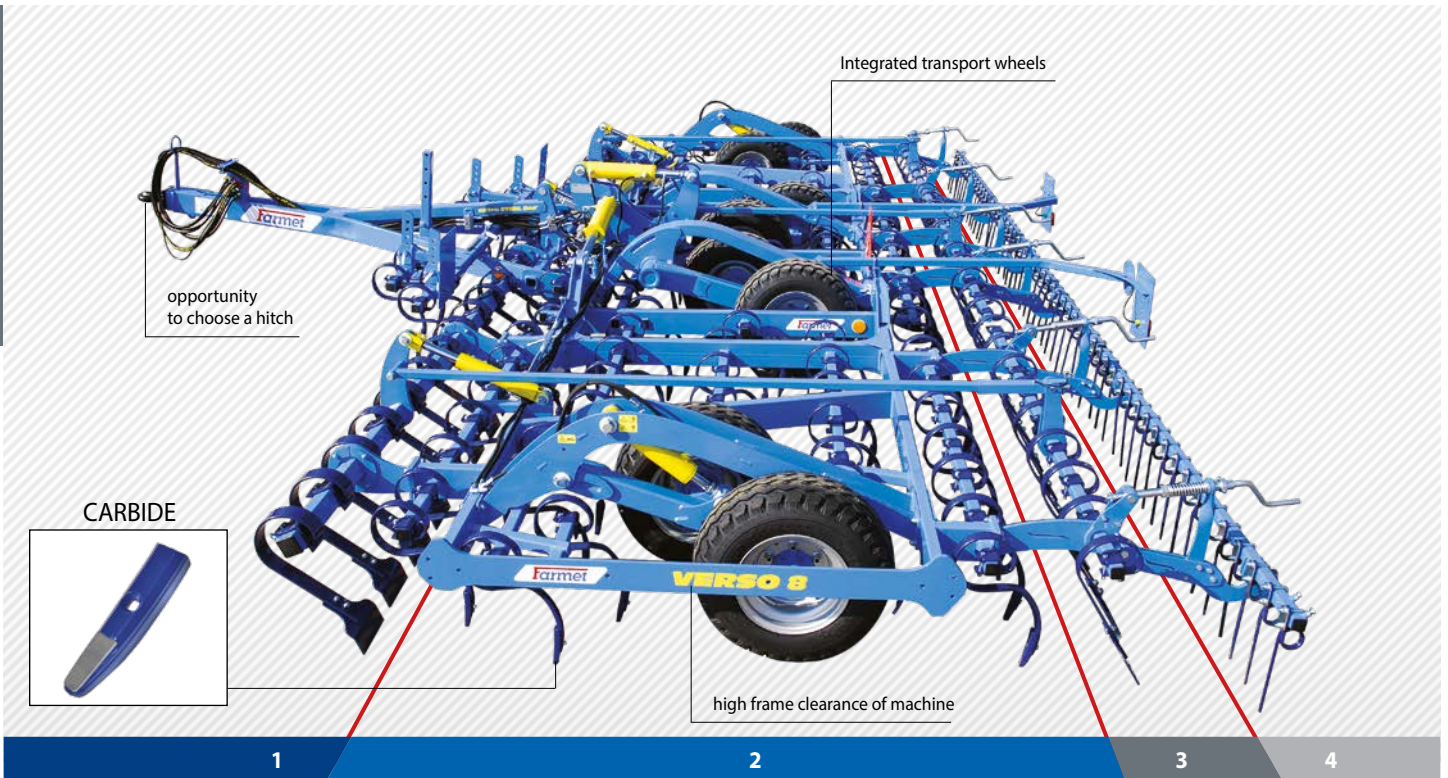

1. Hydraulically controlled front flexi-board leveller ensures spreading of large clods and coarse surface levelling.
2. Semi-flexible tines with chisels of th width 37 mm (1.5") in five rows ensure intensive and fine soil cultivating up to the depth of 10 cm (4").
3. Hydraulically controlled light rear flexi-board leveller levels unevenness of the soil.
4. The rear harrow levels the soil.



Technical parameters	Units	Verso 6 PS	Verso 7 PS	Verso 8 PS	Verso 9 PS
Working width	mm / ft	6000 / 19' 8"	7000 / 22' 11"	8000 / 26' 3"	9000 / 29' 6"
Transport width	mm / ft	3000 / 9' 10"	3000 / 9' 10"	3000 / 9' 10"	3000 / 9' 10"
Transport height	mm / ft	3160 / 10' 4"	3720 / 12' 2"	4000 / 13' 1"	4580 / 15'
Total machine length	mm / ft	6800 / 22' 4"	6800 / 22' 4"	6800 / 22' 4"	6800 / 22' 4"
Working depth	mm / in	0-100 / 0"-4"	0-100 / 0"-4"	0-100 / 0"-4"	0-100 / 0"-4"
Number of tines	pcs	77	91	101	115
Working performance	ha/h (ac/h)	8.0-10.0 (19.8-24.7)	9.0-11.0 (22.2-27.2)	10.0-12.0 (24.7-29.7)	11.0-13.0 (27.2-32.1)
Towing vehicle	kW / HP	130-195 / 180-270	150-225 / 205-308	160-240 / 220-330	180-270 / 245-368
Machine weight	kg / lb.	3570 / 7870	3920 / 8642	3960 / 8730	4350 / 9590



More info at www.farmet.eu

FALCON

Tillage, re-compaction, fertilisation and sowing in one pass



SOWING



Modular seed drill Falcon is especially suitable for both minimizing and classic technologies. It is also suitable for sowing in all conditions and for all technologies – after ploughing, stubble-cultivation, into mulch and without preparation. It enables sowing of two crops or variants, sowing with additional fertilisation and use of STRIP-TILL technology of strip soil processing. Row spacing is user selectable. Perfectly prepares the seedbed with optimum soil compaction.

**10–20 km/h
(6–12 mph)**

FALCON COMPACT

FALCON PRO

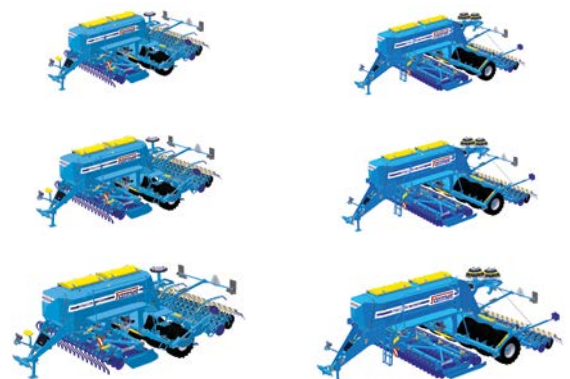

FALCON SW

FALCON TANDEM



eXtra STEEL line®
ultra high strength steel technology

FALCON

MODULAR SYSTEM FALCON PRO

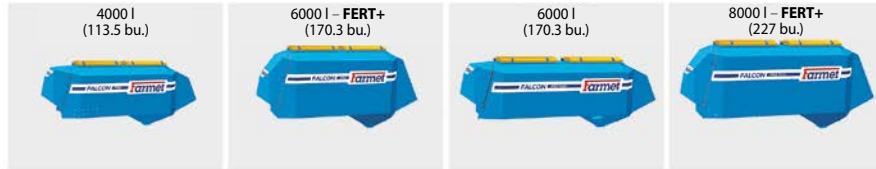
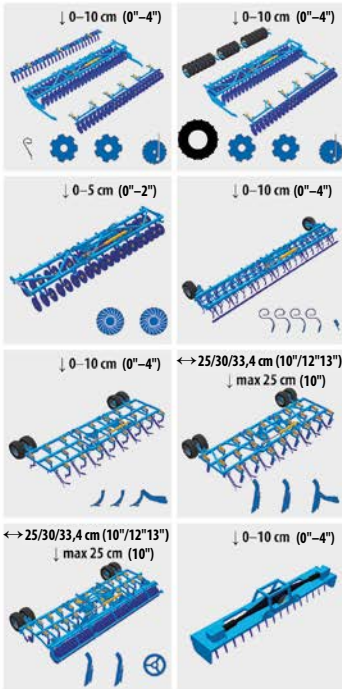

MICRO DRILL



D

↔ 12,5/25 cm (5"/12")

↓ max. 120 kg (265 lb)

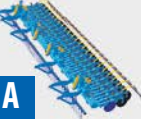

A

↔ 15/30 cm (6"/12")

↓ max. 120 kg (265 lb)



B

↔ 70/75 cm (27.5"/29.5")

↓ max. 350 kg (772 lb)



C

↔ 16,7 cm (6.5")

↓ max. 120 kg (265 lb)

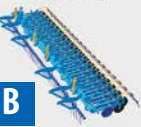

B



FALCON PRO MODULAR SYSTEM

ELECTRONIC SYSTEM

ME SMART 570
ISO-BUS (5,7")



TOPCON XD+
ISO-BUS (12,1")



METOUCH 800
ISO-BUS (8")



ME BASIC
TERMINAL
ISO-BUS (5,7")



HOPPER 8000 L (227 bu.)



Two-chamber hopper with increased capacity for high-performance sowing with fertiliser application. Possible sowing of two crops. Minimization of lost filling times. Easy to fill. High stability due to the dimensioned pneumatic roller.

SOWING

FALCON PRO SWITH SCREW CONVEYOR

easy hopper filling by seed and fertiliser from the ground

NEW



OVERPRESSURE HOPPER



Overpressure hopper

- Accurate seed and fertiliser metering at low and high rates.
- Saving seeds and fertiliser.



FALCON

SOWING OF MORE CROPS IN ONE PASS

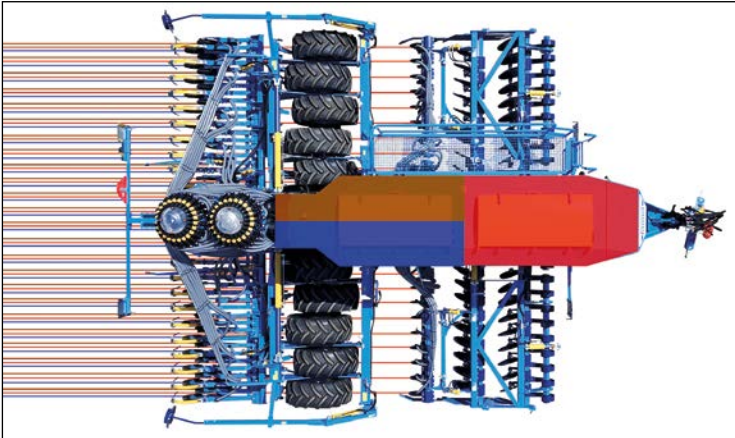

Sowing of 2 crops



Sowing of 3 crops

FULLY ELECTRONIC CONTROL AND CHECKING OF SEED DRILL FUNCTIONS

- A clear terminal communicating via ISOBus network with the tractor and the machine.
- Electrically driven dosing device with fully automatic seeding control according to the current working speed.
- optoelectronic control of seed flow to each coulters.

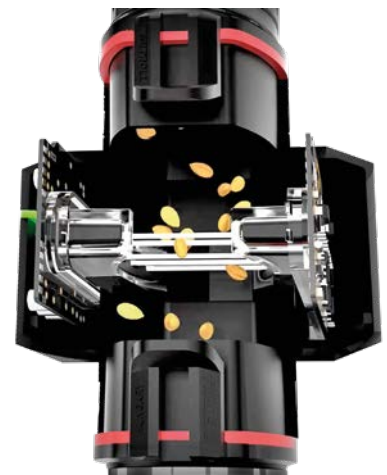

VARIABLE FERTILISER AND SEED DOSING

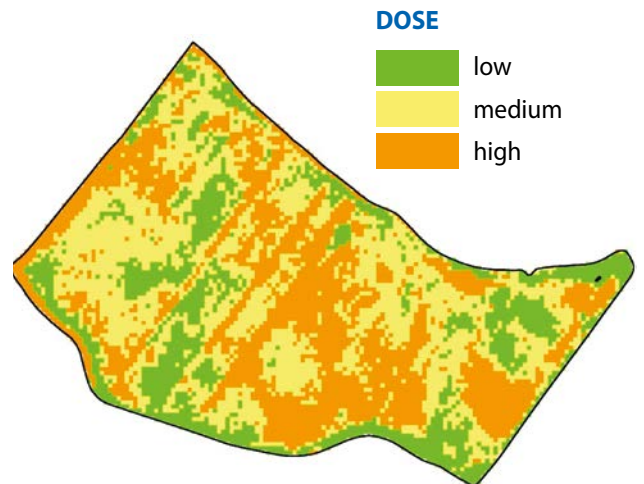

SECTION CONTROL

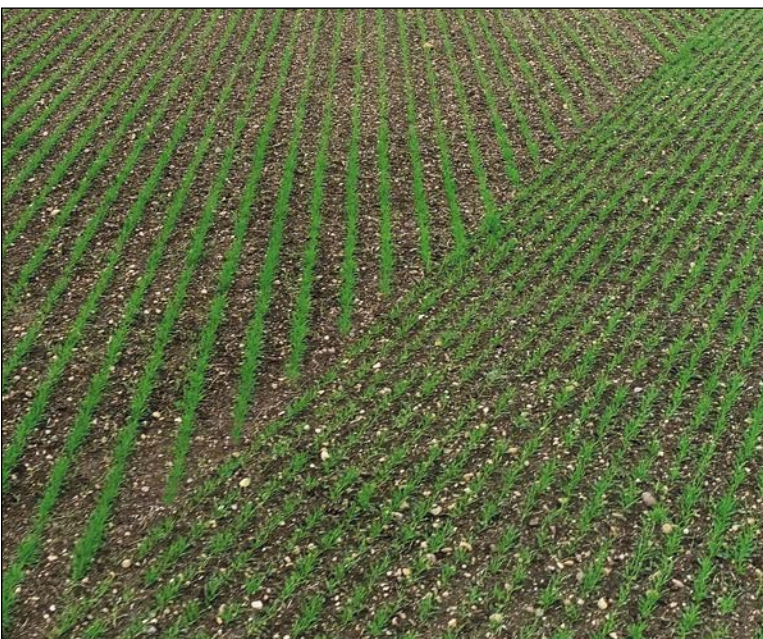
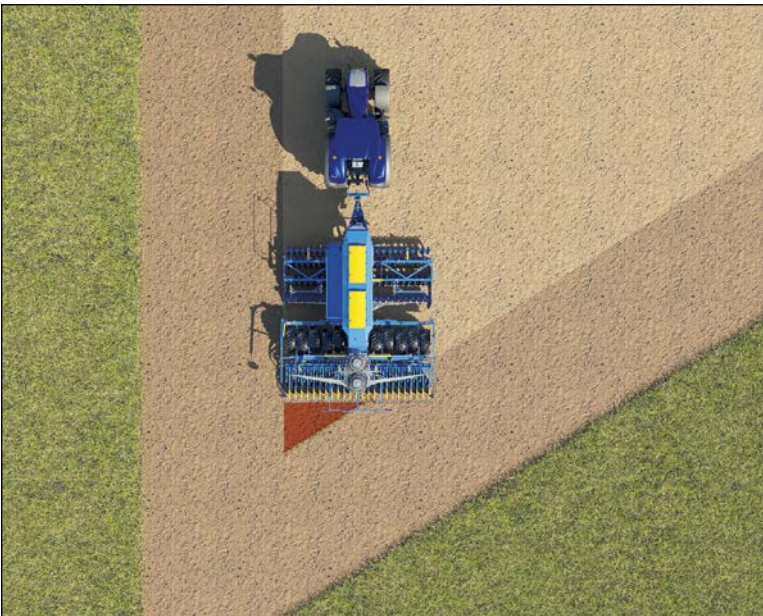

Controlled section shutdown

- Optimal sowing of wedges and headlands without double sowing or empty places.
- Any size of sowing sections.
Minimal section = 1 seeding coulters.
- Sowing edges after sowing the field.
- Saving seeds.
- ISO-BUS compatible control system.

FALCON COMPACT



Tillage, re-compaction, fertilisation and sowing in one pass



10–20 km/h
(6–12 mph)

NEW

Falcon Compact is a lighter and more compact version of the Falcon seed drills with a control electronic system. The Falcon Compact seed drill is designed for establishing growth after ploughing, deep loosening and into stubble cultivation with an inter-row seed spacing of 12,5 / 15 / 16,7 cm (5" / 6" / 6.5").



NEW

NEW

NEW

Technical parameters	Units	Falcon 3 COMPACT	Falcon 4 COMPACT	Falcon FIX 4 COMPACT	Falcon 6 COMPACT	Falcon 7.2 COMPACT
Working width	mm / ft	3000 / 9' 10"	4000 / 13' 1"	4000 / 13' 1"	6000 / 19' 8"	7200 / 23' 7"
Transport width	mm / ft	3000 / 9' 10"	3000 / 9' 10"	4000 / 13' 1"	3000 / 9' 10"	3000 / 9' 10"
Transport height	mm / ft	2800 / 9' 2"	2800 / 9' 2"	2800 / 9' 2"	2800 / 9' 2"	2800 / 9' 2"
Hopper capacity without additional fertilisation	l (bu.)	2800 / 4000 (75.5 / 113.5)	2800 / 4000 (75.5 / 113.5)	2800 / 4000 (75.5 / 113.5)	4000 / 5000 (113.5 / 141.9)	4000 / 5000 (113.5 / 141.9)
Working performance	ha/h (ac/h)	3.0–4.5 (7.4–11.1)	4.0–6.0 (9.9–14.8)	4.0–6.0 (9.9–14.8)	6.0–9.0 (14.8–22.2)	7.2–11.3 (17.8–27.9)
Towing vehicle	kW / HP	88 / 120	103 / 140	103 / 140	147 / 200	183 / 250
Machine weight	kg / lb.	3500 / 8377	4800 / 10582	4400 / 9700	6800 / 14991	8600 / 18959

More info at www.farmet.eu



iPad wifi connect

ME SMART 570
ISO-BUS (5,7")

TOPCON XD+
ISO-BUS (12,1")

ME TOUCH 800
ISO-BUS (8")

ME BASIC
TERMINAL
ISO-BUS (5,7")



up to 120 kg
up to 265 lb

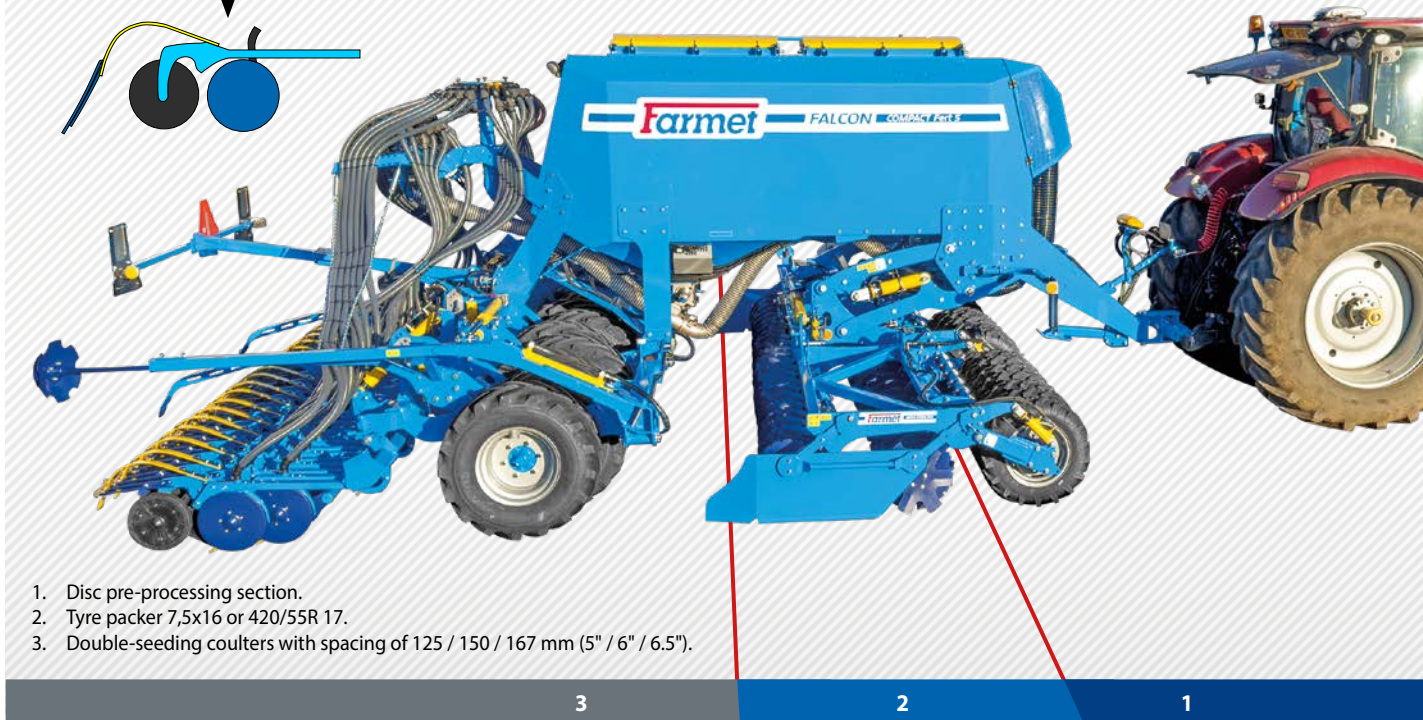
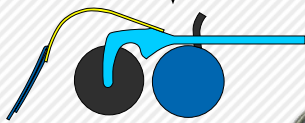

1. Disc pre-processing section.
2. Tyre packer 7,5x16 or 420/55R 17.
3. Double-seeding coulters with spacing of 125 / 150 / 167 mm (5" / 6" / 6.5").

3

2

1

WIDE TYRES FOR SPACING OF 125 / 167 MM (5" / 6.5")

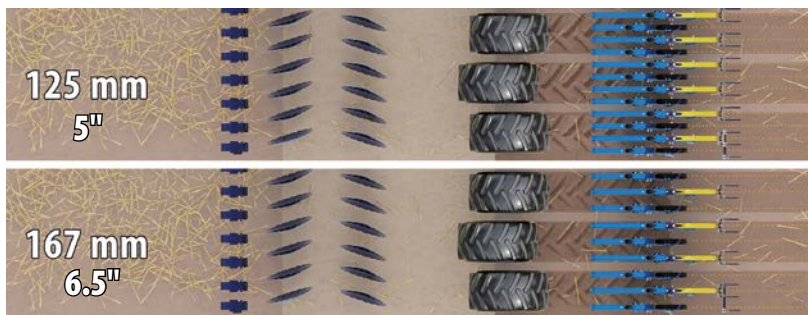

NARROW TYRES FOR SPACING OF 150 MM (6")



FALCON PRO



- Due its modularity, modular sowing machine Falcon is intended for all conditions and all technologies. Especially the minimizing technology uses **sowing into unprepared soil with the applied fertiliser**. At conventional technology with pre-sowing soil preparation, high working speed, **excellent stability and manoeuvrability of the machine** can be used.
- Falcon combines soil preparation, additional fertilisation and sowing itself into one operation, **into one pass**. The conception of the seeding machine is based on **optionality and combination of all working sections** and their interchangeability. Between the pre-processing and seeding sections there is the tyre-packer with integrated transport axle. The seedbed before each seeding coulters is perfectly recompactd by the flotation (low-pressure) tyres. The wheels are resistant against damage.
- Falcon is a very compact machine with a low weight and low pulling requirements. **The management and control system** is, of course, a part of the machine.

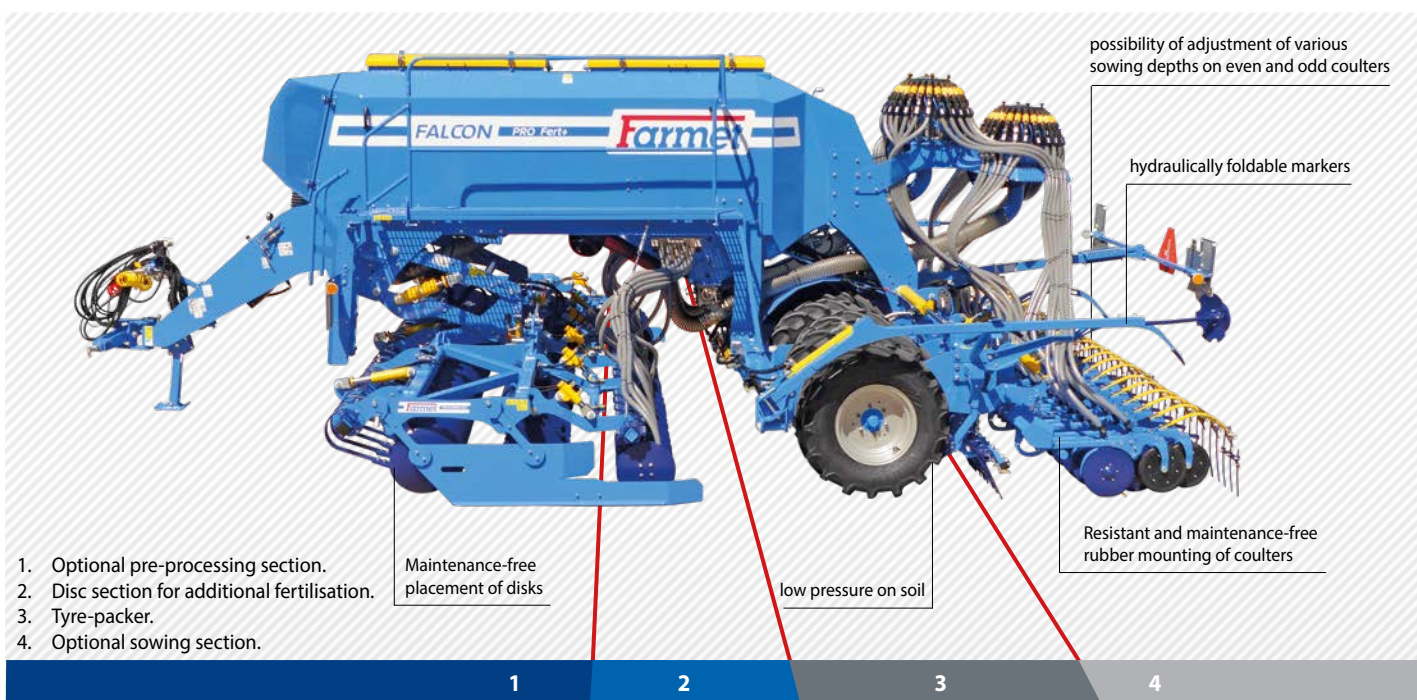

VERSION FERT+: FERTILISER IS APPLIED BY FERTILISATION UNITS

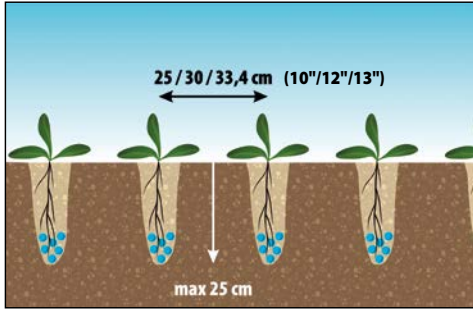
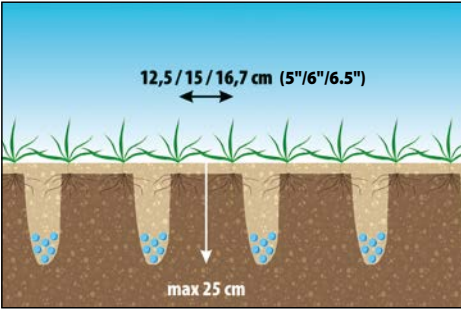
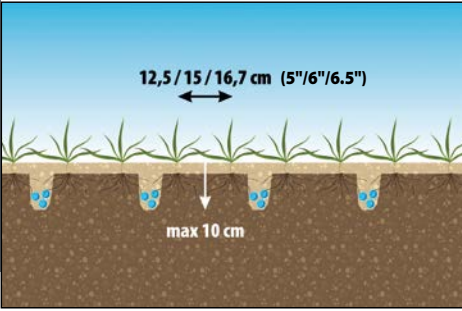

VERSION FERT S: FERTILISER IS APPLIED DIRECTLY TO THE SEED

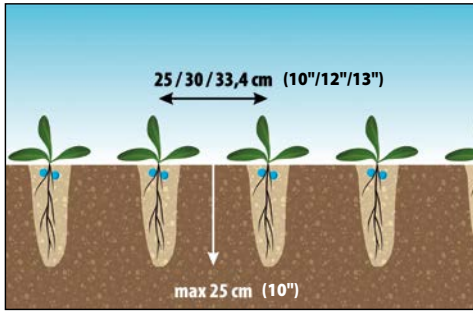
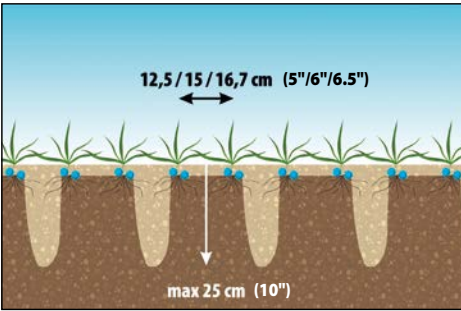
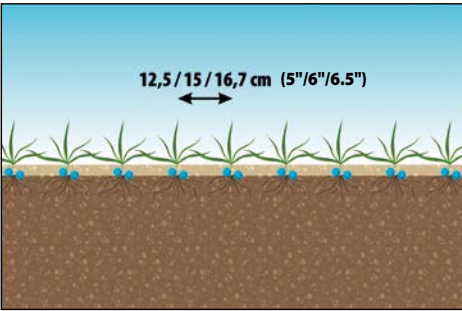

Sowing of cereals into narrow lines with possibility of fertilisation under the heel.

Sowing of rape with deep cultivating and fertiliser application.

Precision sowing of corn and fertiliser application.



FALCON PRO

SPECIAL OPTIONAL EQUIPMENT

D



MICRO DRILL

NEW



*Possibility
of sowing
up to 4 crops*

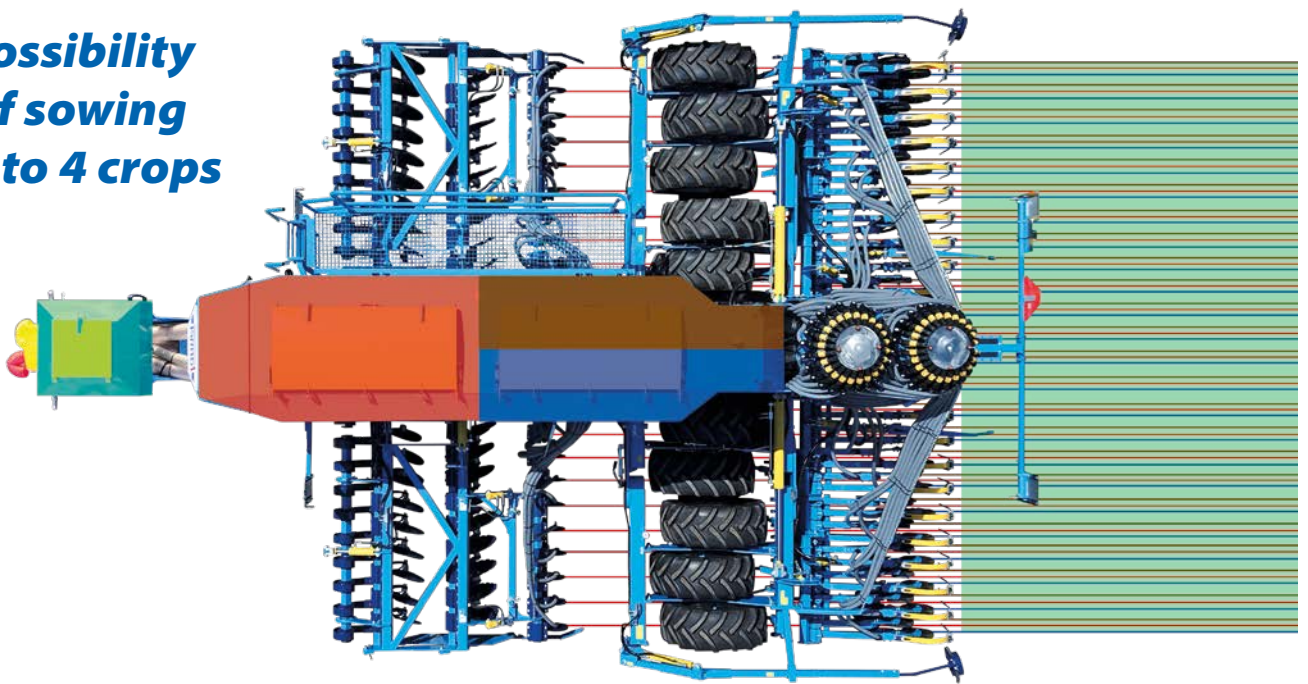

SOWING



8000 l (227 bu.)- FERT+



A

NARROW ROW SPACING DRILL TECHNOLOGY



Narrow row spacing drill technology

- Surface soil cultivation into the seedbed depth.
- Option of fertilisation under seeds.
- Sowing all common crops.



Technical parameters	Units	Falcon 3 PRO	Falcon 4 PRO	Falcon 4 FIX PRO	Falcon 6 PRO	Falcon 8 PRO
Working width	mm / ft	3000 / 9' 10"	4000 / 13' 1"	4000 / 13' 1"	6000 / 19' 8"	8000 / 26' 3"
Transport width	mm / ft	3000 / 9' 10"	3000 / 9' 10"	4000 / 13' 1"	3000 / 9' 10"	3000 / 9' 10"
Transport height	mm / ft	3100 / 10' 2"	3350 / 11'	3100 / 10' 2"	3350 / 11'	4000 / 13' 1"
Hopper capacity without additional fertilisation	l / bu.	4000 / 113.5	4000 / 113.5	4000 / 113.5	4000 / 113.5	4000 / 113.5
Hopper capacity with additional fertilisation	l / bu.	6000 / 170.3	6000 / 170.3	6000 / 170.3	6000 / 170.3	6000 / 170.3
Working performance	ha/h (ac/h)	3.0–4.5 / 7.4–11.1	4.0–6.0 / 9.9–14.8	4.0–6.0 / 9.9–14.8	6.0–9.0 / 14.8–22.2	8.0–12.0 / 19.8–29.7
Towing vehicle	kW / HP	92 / 125	117 / 160	117 / 160	161 / 220	205 / 280
Machine weight	kg / lb.	4830–5840 / 10648–12875	5340–7580 / 11773–16711	5180–7350 / 11420–16204	6800–8920 / 14991–19665	8440–10240 / 18607–22575

More info at www.farmet.eu



FALCON PRO STRIP TILL

B

STRIP TILL SOWING TECHNOLOGY

The best solution for rapeseed.



STRIP TILL & SOWING & FERTILISATION

STRIP TILL sowing technology

- Deep cultivation, additional fertilisation (optional) and sowing at one line.
- Strip (partial) processing of the soil to the depth.
- Sowing of winter oilseed rape and special crops.

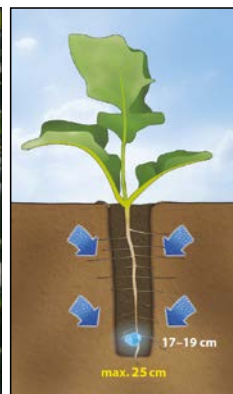

SOWING

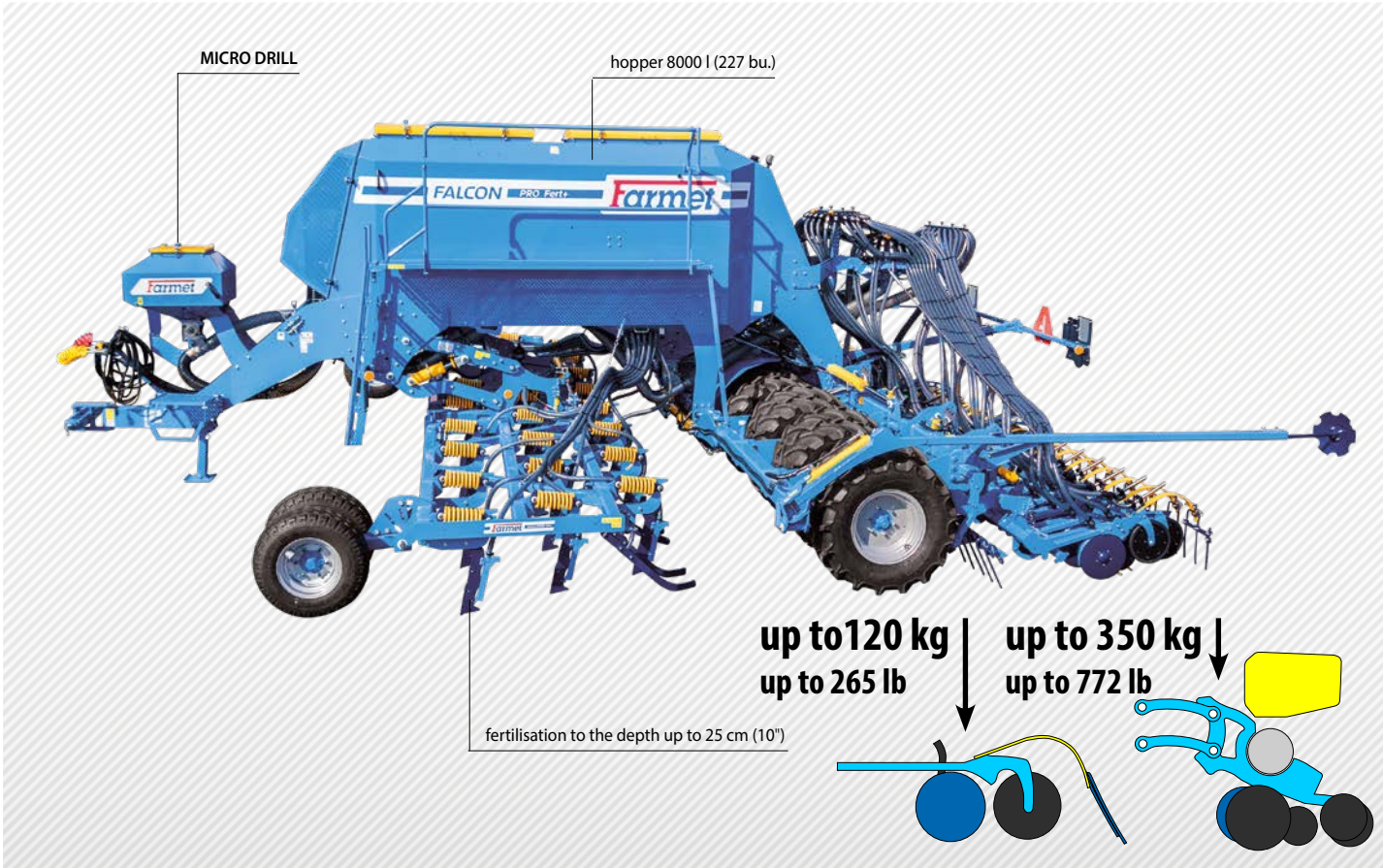

FALCON PRO Fert+ QH

C

SOWING TECHNOLOGY OF WIDE ROW CROPS & FERTILISATION



Sowing technology of wide row crops

- Sowing at precisely defined distance (e.g., corn, sunflower).
- Spacing of 75 cm (30").
- Possibility of additional fertilisation with disc applicators from both sides of the row.

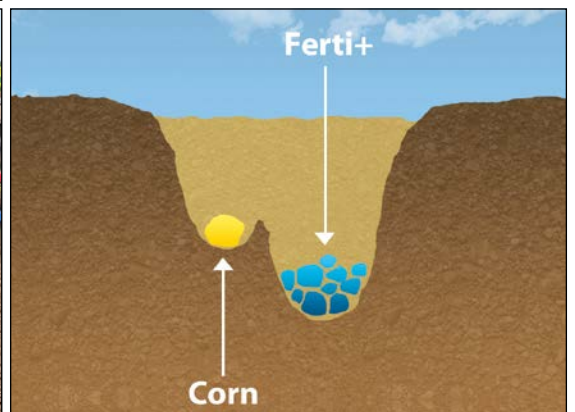

SOWING

FALCON PRO QH (QUICK HITCH)

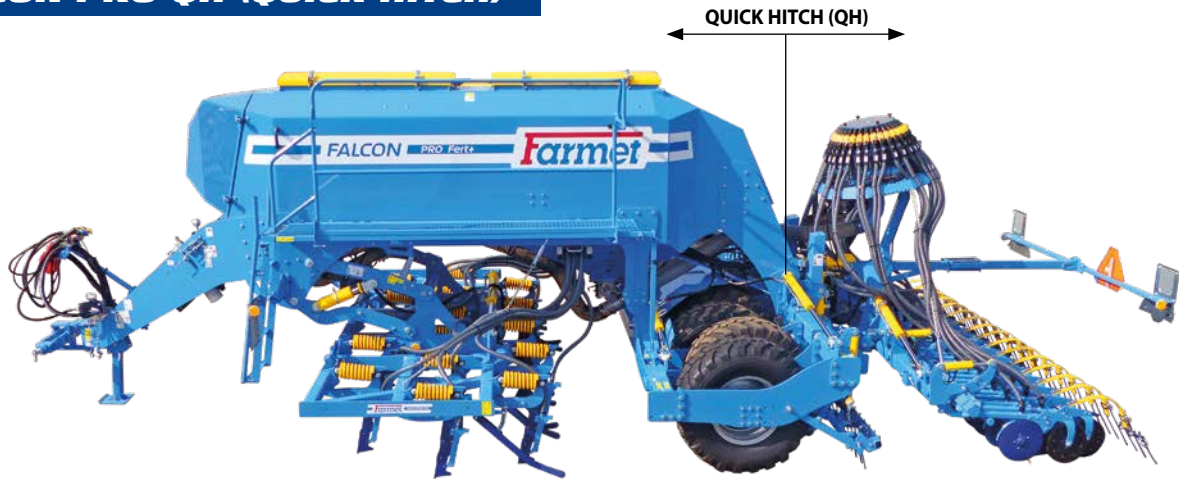

Aggregation of sowing sections by three-point hitch

- A machine is standardly equipped with a three-point hitch.
- Universal use for sowing all crops.
- Application of various technologies of plant establishment due to exchangeable sections (narrow row sowing, sowing in STRIP, planting).

QUICK EXCHANGE OF THE REAR SECTION

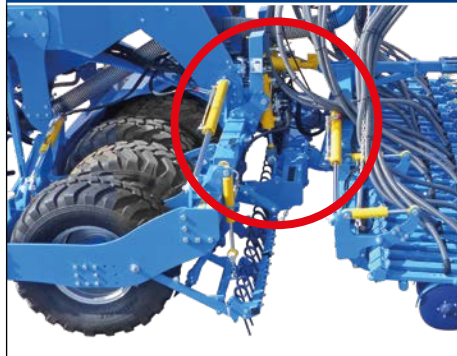

FALCON PRO TANDEM



SHARE SOWING & FERTILISER APPLICATION



8–15 km/h
(5–9 mph)

extra STEEL line
ultra high strength steel technology

The Falcon Pro Tandem seed drill is a modular version of the Falcon Pro seed drill, providing strip seeding using special shares with tandem-configured outputs for seeding and parallel placement of the fertiliser into the root zone. This seeding method is suitable for sowing into mulch, as well as standard cultivated soil. The front and rear tyre rollers provide a high precision depth guidance with accurate working depth adjustment of the seeding discs. A highly durable and robust frame means the machine is suitable for stony soils.

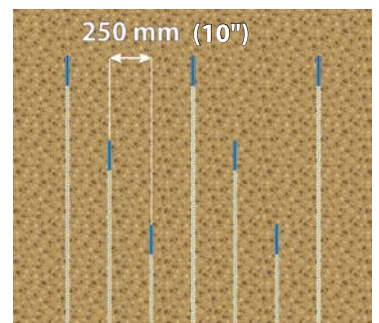
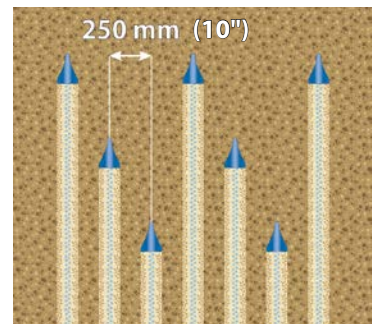
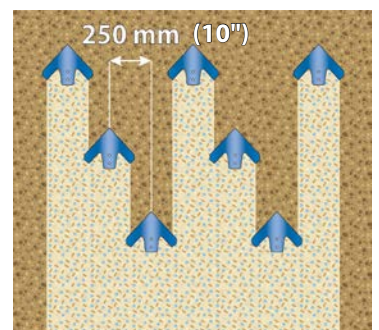

- The Falcon Pro Tandem seed drill uses the modular foundation of Falcon Pro, equipped with the front seeding section and tyre packer with three rows of special seeding shares. The seeding shares are followed by a leveller system, excellent for effective levelling of the surface and even distribution of crop residue.
- The rear roller equipped with large low-pressure tyres provides very low ground pressure on the soil, even when the seed and fertiliser hoppers are completely full. The robust tyres have high resistance to damage and allow for transportation of the machine at high speeds, even for greater distances or on poor quality roads.
- The special seeding shares with tandem-configured outputs for seeding and parallel placement of fertiliser into the root zone provide quality seeding, even under the conditions of a high quantity of crop residue in mulch seeding technologies. The precise depth guidance by tyre rollers helps achieve seeding depth precision comparable with disc seed drills.
- The robust frame of the machine makes it also suitable for rocky soils.

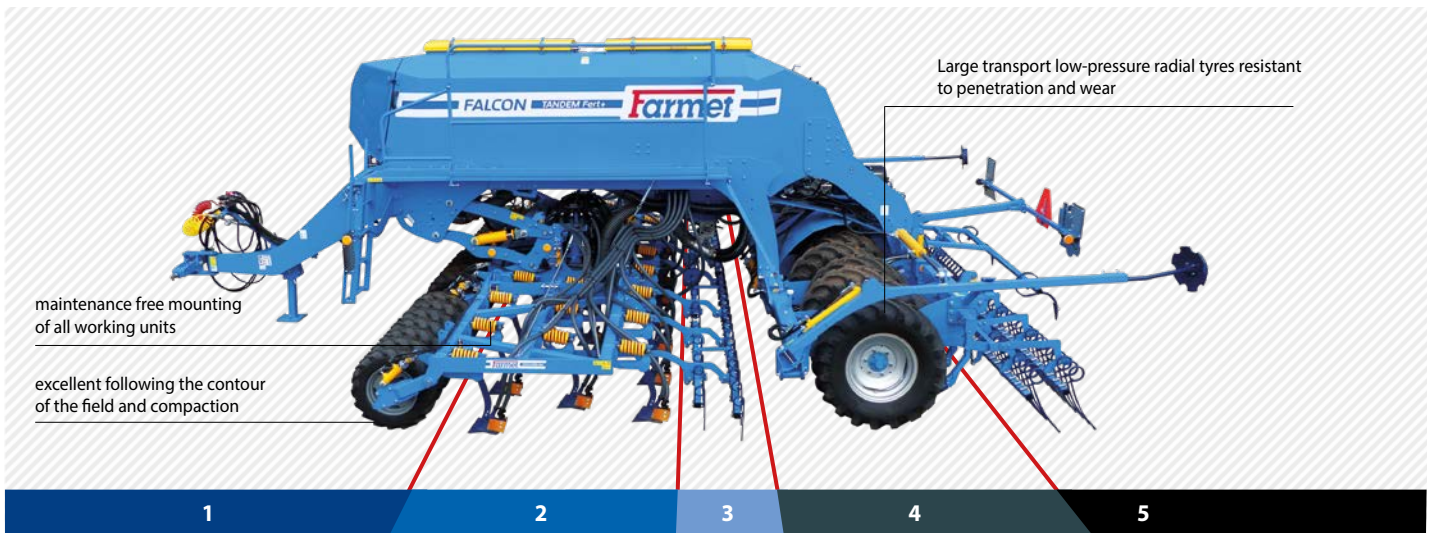

1. Front rubber-tyred roller.
2. Share section for additional fertilisation.
3. Harrow for levelling the surface.
4. Rear rubber-tyred roller.
5. Harrow for levelling the surface.

Technical parameters	Units	Tandem 6 PRO Tandem	Tandem 8 PRO Tandem
Working width	mm / ft	6000 / 19' 8"	8000 / 26' 3"
Transport width	mm / ft	3000 / 9' 10"	3000 / 9' 10"
Transport height	mm / ft	3300 / 10' 10"	4000 / 13' 1"
Total machine length	mm / ft	9000 / 29' 6"	9000 / 29' 6"
Working depth	mm / in	0-100 / 0"-4"	0-100 / 0"-4"
Number of seeding coulters	pcs	24	32
Working performance	ha/h (ac/h)	6.0-9.0 (14.8-22.2)	8.0-12.0 (19.8-29.7)
Towing vehicle	kW / HP	147 / 200	205 / 280
Machine weight	kg / lb.	6500-7500 / 14330-16534	9100-10780 / 20062-23765

More info at www.farmet.eu





Soil preparation, fertilisation and sowing in one pass

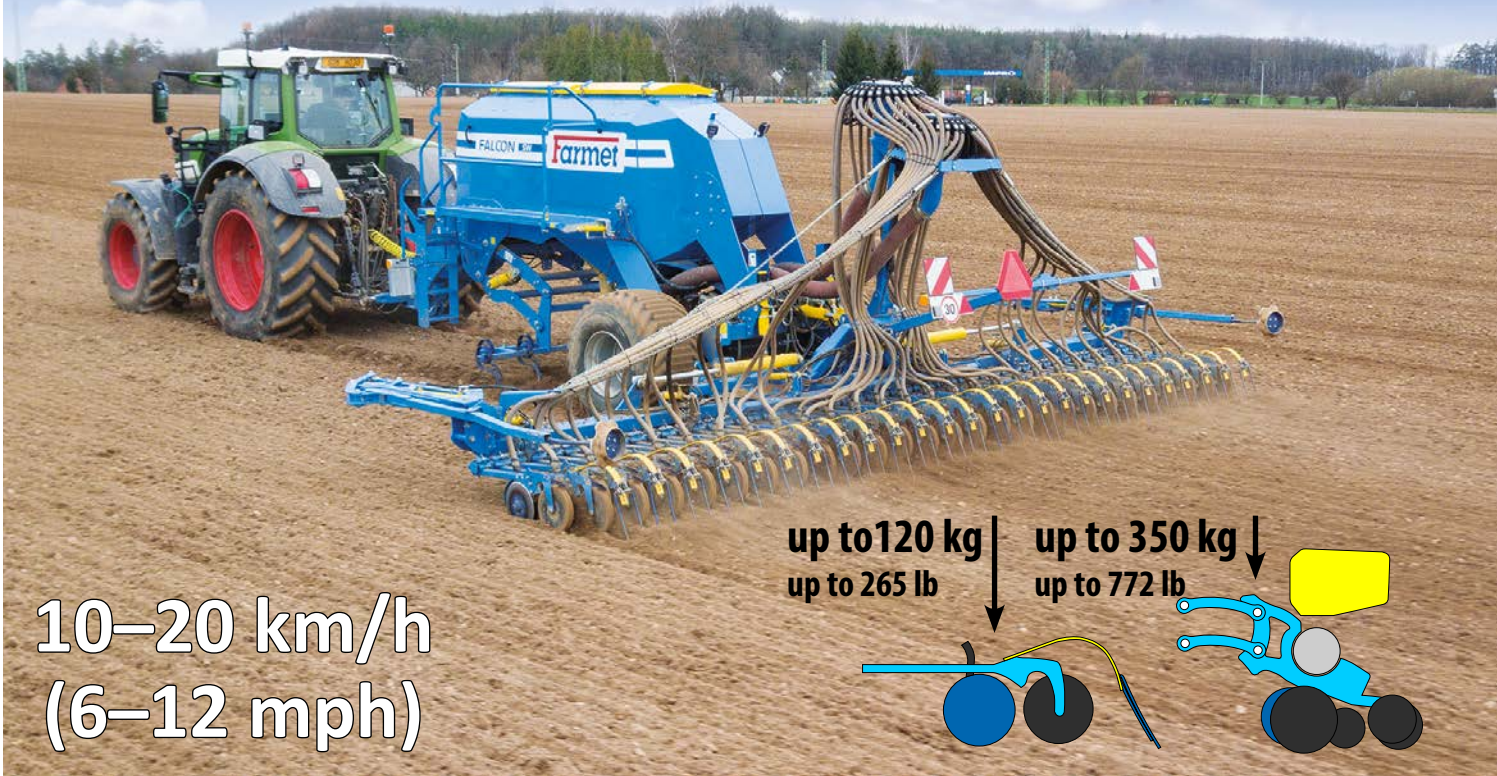

10–20 km/h
(6–12 mph)

up to 120 kg
up to 265 lb

up to 350 kg
up to 772 lb



Falcon SW Modular seed hopper is designed for the sowing of all common crops in different technologies for establishing growth, with the option to choose different sowing sections.

Technical parameters	Units	Falcon SW
Transport width	mm / ft	3000 / 9' 10"
Hopper cap. without additional fertilisation	l bu.	4000 / 6000 113.5 / 170.3
Hopper cap. with additional fertilisation	l bu.	6000 / 8000 170.3 / 227

More info at www.farmet.eu



Wide seeding bar for sowing narrow row-drilled crops.



Mounted seed drill for sowing wide-row crops.



Wide working width sowing section for narrow-row crops sowing.

MODULAR SYSTEM FALCON SW

<p>↓ 0-10 cm (0"-4")</p> <p>4000 I (113.5 bu.)</p>	<p>↓ 0-10 cm (0"-4")</p> <p>6000 I - FERT+ (170.3 bu.)</p>	<p>6000 I (170.3 bu.)</p>	<p>8000 I - FERT+ (227 bu.)</p>	<p>MICRO DRILL</p>	
<p>↓ 0-10 cm (0"-4")</p>	<p>↓ 0-10 cm (0"-4")</p>	<p>FALCON SW MODULAR SYSTEM</p>			<p>↔ 12.5/25 cm (5"/12") ↓ max. 120 kg (265 lb)</p>
<p>↓ 0-5 cm (0"-2")</p>	<p>↓ 0-10 cm (0"-4")</p>				<p>↔ 15/30 cm (6"/12") ↓ max. 120 kg (265 lb)</p>
<p>↓ 0-10 cm (0"-4")</p>	<p>↓ 0-10 cm (0"-4")</p>				<p>↔ 70/75 cm (27.5"/29.5") ↓ max. 350 kg (772 lb)</p>
<p>↔ 25/30/33,4 cm (10"/12"/13") ↓ max 25 cm (10")</p>	<p>↔ 25/30/33,4 cm (10"/12"/13") ↓ max 25 cm (10")</p>				<p>↔ 16.7 cm (6.5") ↓ max. 120 kg (265 lb)</p>

ELECTRONIC SYSTEM

<p>ME SMART 570 ISO-BUS (5,7")</p>	<p>TOPCON XD+ ISO-BUS (12,1")</p>	<p>ME TOUCH 800 ISO-BUS (8")</p>	<p>ME BASIC TERMINAL ISO-BUS (5,7")</p>
---	--	---	--



STRIP TILL SOWING TECHNOLOGY

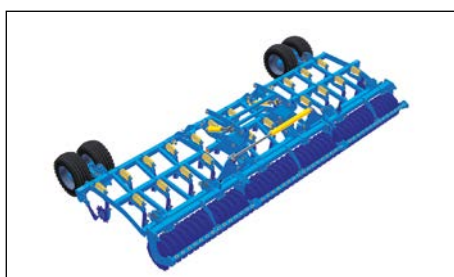



Reinforced storage hopper with high capacity



eXtra STEEL line®
ultra high strength steel technology

Large-capacity two-chamber storage hopper with a capacity of 5 m³ (141.9 bu.) or 8,5 m³ (241.2 bu.) designed mainly for aggregation with tillage machines with fertiliser application. The storage hopper can also be aggregated with a sowing section for high-capacity sowing. Large transport wheels and solid construction allow to achieve high transport and working speed.



- The hopper is equipped with two high-quality stainless steel screw metering units of hydraulically driven for the application of up to 2 types of fertiliser or seed.
- Two-chamber, overpressure, large 5000 l (141.9 bu.) hopper minimizes lost filling times.
- Possibility of aggregation with mounted and semi-mounted machines.
- ISO-BUS compatible control system.
- Large transport wheels (650/65-30.5) and massive construction dimensioned for fast movement in the field

Options of aggregation

5000 l (141.9 bu.)



8500 l (241.2 bu.)

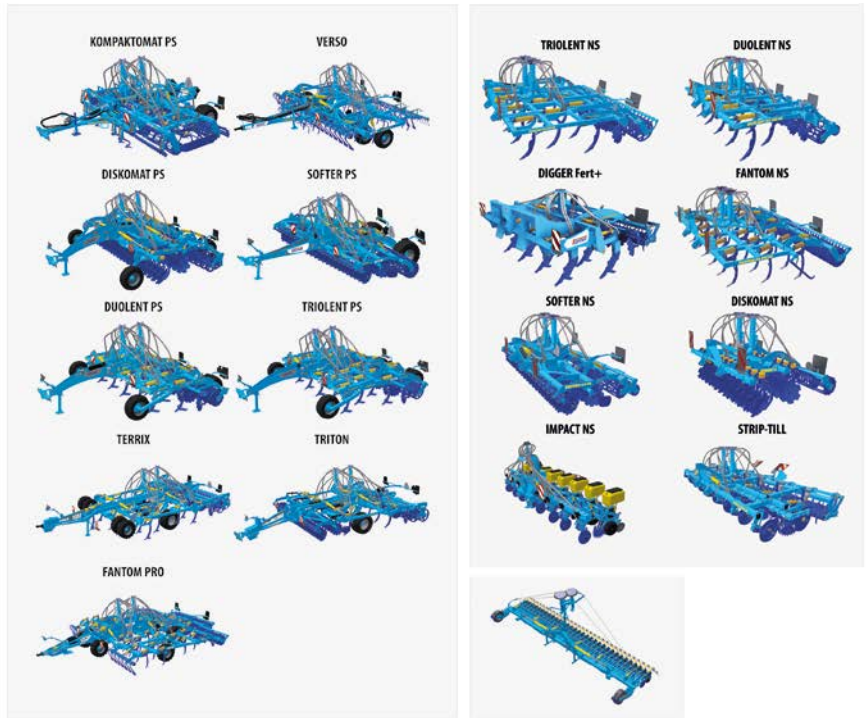



Powerful wide working width seed drill with high down pressure of coulters and high throughflow



eXtra STEEL line
ultra high strength steel technology

Freya is a very compact machine with a low weight and low pulling requirements. The management and control system is, of course, a part of the machine.

10–20 km/h
(6–12 mph)

SECTION CONTROL



Controlled section shutdown

- Optimal sowing of wedges and headlands without double sowing or empty places.
- Any size of sowing sections. Minimal section = 1 seeding coulters.
- Saving seeds.
- ISO-BUS compatible control system.

NEW

even seed dosing in entire working width

up to 80 kg
up to 176 lb

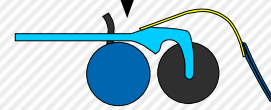

high down pressure
up to 80 kg (176.4 lb)
on each coulters

massive transport axle

support wheels for precise depth guiding of the coulters

1

2

1. Transport axle.
2. Double disc sowing section

High performance and quality of work

- High working speed up to 20 km/h (12 mph).
- **Low pulling requirement** due to a low weight and large wheels.
- **Shorter idle periods for filling of hoppers** due to a large capacity.
- **Fast turning at headlands** due to a short compact design.
- **Precise depth guidance** with optimum soil compaction.

Robust design

- The flexible construction of the frame **excellently absorbs shocks and traces the terrain.**
- **Maintenance-free placement of all discs** ensuring operation of the machine without additional lubrication.
- **Durable and maintenance-free rubber mounting of the drill coulters** for adaptation to terrain with protection against overload.
- Due to minimum of adjusting and lubricating points the operation and subsequent maintenance are **very easy steps** that anybody can perform.

Technical parameters	Units	Freya 6	Freya 8	Freya 10	Freya 12
Working width	mm / ft	6000 / 19' 8"	8000 / 26' 3"	10000 / 32' 9"	12000 / 39' 4"
Transport width	mm / ft	3000 / 9' 10"	3000 / 9' 10"	3000 / 9' 10"	3000 / 9' 10"
Transport height	mm / ft	3200 / 10' 6"	3200 / 10' 6"	3200 / 10' 6"	3200 / 10' 6"
Total machine length	mm / ft	9000 / 29' 6"	9000 / 29' 6"	9000 / 29' 6"	9000 / 29' 6"
Hopper volume	l / bu	3200 / 90.9	3200 / 90.9	4000 / 113.6	4000 / 113.6
Working depth	mm / in	0-70 / 0"-2.75"	0-70 / 0"-2.75"	0-70 / 0"-2.75"	0-70 / 0"-2.75"
Number of seeding coulters	pcs	40 / 48	52 / 64	66 / 80	80 / 96
Working performance	ha/h (ac/h)	6.0-8.0 (14.8-19.8)	8.0-10.0 (19.8-24.7)	10.0-13.0 (24.7-32.1)	12.0-15.0 (29.7-37.1)
Towing vehicle	kW / HP	130 / 175	165 / 220	195 / 260	220 / 295
Machine weight	kg / lb.	5900 / 13007	6750 / 14881	7600 / 16755	8500 / 18739

More info at www.farmet.eu



IMPACT



High-speed planting with fertilisers application



up to 350 kg
up to 772 lb

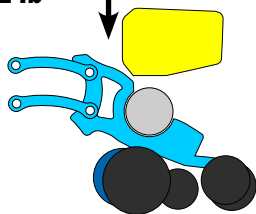

6–15 km/h
(4–9 mph)

Impact is a modern planter with an advanced pneumatic seeding system and top spec electronic seeding control system providing a high precision seeding with high working speeds.

- Impact is designed for precise seeding of wide-row crops such as corn, sunflower, and rapeseed with the option of additional fertilisation using granulated fertilisers. Impact has a heavy duty frame to ensure accurate placement of fertiliser and seeds at the required depth, with ability to work in heavier soil conditions.
- The design of the Impact planter allows high working speeds from 6-15 km/h (4-9 mph) depending on the soil conditions.
- The seeding units are equipped with a highly advanced seeding control system. Specially placed sensors scan each individual seed and assess accurately for gaps or doubles. All the working and output information is displayed on the ISO-bus terminal in the tractor cab. All of the machine functions can be constantly checked by the operator and on-the-move modifications, adjustments and speed can be made according to the soil conditions.

ELECTRONIC SEEDING CONTROL SYSTEM

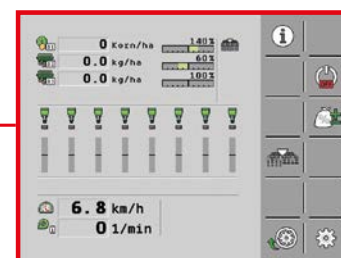

ME SMART 570
ISO-BUS (5,7")

TOPCON XD+
ISO-BUS (12,1")

ME TOUCH 800
ISO-BUS (8")

ME BASIC
TERMINAL
ISO-BUS (5,7")



High performance and quality of work

- **High working speed** of up to 15 km/h (9 mph), high seeding rate reliability.
- **Highly advanced electronic control system** for each seed placed.
- Electronic control of all functions of the machine during work – ISO bus system.
- Fertilisation with tandem-configured disc units.
- **Strip-till soil pre-processing** and seedbed preparation.

Robust design

- Hydraulic folding into the transportation position.
- **Durable and maintenance-free bearing of all discs.**
- **Durable and maintenance-free rubber mounted** of fertilisation units with overload protection.
- **Highly durable seeding units** with flexible pressure adjustment.

Technical parameters	Units	Impact 6	Impact 8
Working width	mm / ft	4500 / 14' 9"	6000 / 19' 8"
Number of seeding units	pcs	6	8
Transport width	mm / ft	3000 / 9' 10"	3000 / 9' 10"
Transport height	mm / ft	2400 / 7' 10"	2400 / 7' 10"
Total machine length	mm / ft	2350 / 7' 8"	2350 / 7' 8"
Number of fertilising discs	pcs	12	16
Working performance	ha/h (ac/h)	4.5–6.0 (11.1–14.8)	6.0–9.0 (14.8–22.2)
Towing vehicle	kW / HP	75 / 100	90 / 125
Machine weight	kg / lb.	2700 / 5952	3200 / 7055

More info at www.farmet.eu



1. Fertilisation using disc units.
2. Precise seeding units.

SOWING TECHNOLOGY OF WIDE ROW CROPS & FERTILISATION

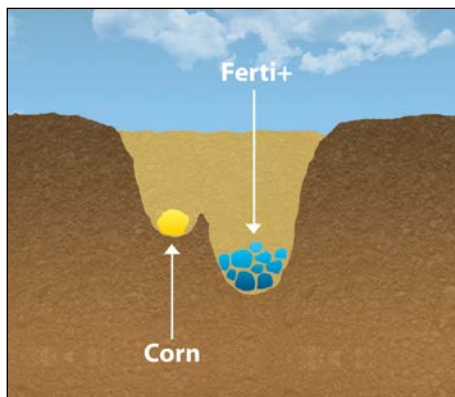

FALCON FH + IMPACT



FALCON FH



High compact, overpressure front hopper with unique design

NEW



Front metering hopper for granulated fertiliser or seed. It utilizes the free capacity of the tractor's front linkage and reduces rear axle loads. It is equipped with a roller metering unit and a pneumatic fertiliser (seed) transport system. In conjunction with the Strip-till or Digger Fert+ machines it ensures a sufficient supply of fertiliser and precise metering during work. The metering hopper can also be used with some Monsun seed drills. **The hopper volume is 1,600 litres (1 metering unit) or 2,200 litres (2 metering units).**



Smartly designed machine

- Light carried design with large capacity hopper.
- Precise seed metering in the range from 2 to 380 kg (4.4-838 lb.).



Transport position.



Working position.



APPLICATION SETS

FALCON HW – storage hopper

5000 l or 8500 l (142 bu. or 241 bu.)



FALCON FH – front hopper

1600 l or 2200 l (45 bu. or 62 bu.)



Sets for the application of granulated fertilisers for soil cultivators.

KOMPAKTOMAT PS



VERSO



DISKOMAT PS



SOFTER PS



DUOLENT PS



TRIOLENT PS



TERRIX



TRITON



FANTOM PRO



TRIOLENT NS



DUOLENT NS



DIGGER Fert+



FANTOM NS

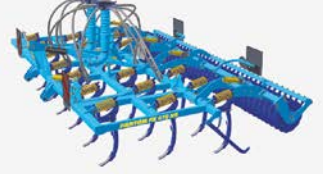

SOFTER NS



DISKOMAT NS

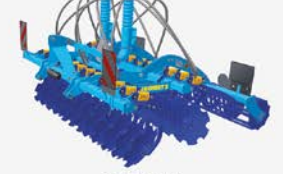

IMPACT NS



STRIP-TILL



MULTISTRIP

& SYNCULT

Application of liquid organic fertilisers and tillage in one pass



Excellent subsurface dispersion of liquid organic fertilisers and high quality tillage also in conditions of extreme drought or wetness. The soil opens in front of the coulters and closes again behind the coulters. The fertiliser is immediately covered and thus CO₂, NH₃ and NO_x emissions are significantly eliminated.

- Special tilling coulters provide porous zones for fertiliser infiltration.
- The fertiliser is spread with wide spray end pieces into wide strips.
- Application up to an adjustable depth of 15–30 cm (6"–12").
- Tilling tine with a spacing of 37.5 cm (15") are hydraulically protected.
- The chisels are fitted with carbide plates.
- Leveller and rear SDR roller ensure fast soil closing and optimal re-compaction.
- The soil is very well processed and allows direct sowing of crops.
- Due to the good fertiliser distribution, even higher doses can be applied.

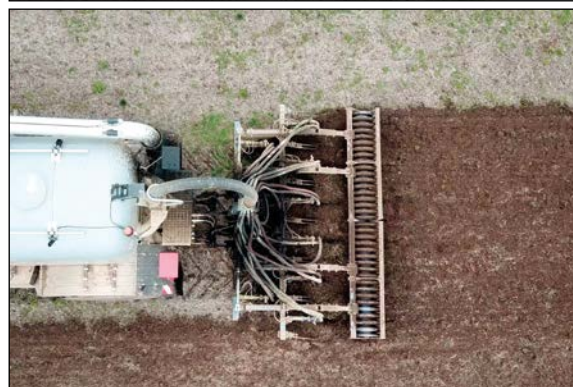

eXtra STEEL line
ultra high strength steel technology

Technical parameters	Units	MULTISTRIP 450 NS
Working width	mm / ft	4500 / 14' 9"
Transport width	mm / ft	2600 / 8' 6"
Working depth	mm / in	150–300 / 6"–12"
Number of tines	pcs	11
Tine spacing	mm / in	375 (750) / 15" (30")
Working performance	ha/h (ac/h)	3.6–5.4 / 8.9–13.3





SOFTER & SYNCULT

Effective incorporation
of slurry or digestate



The slurry or digestate application system for tillage machines consists of a distribution system and a special distributor head. The distributor head has a rotor driven by a hydraulic motor, which ensures an even distribution of fertilizer to all outlets and cutting solids in fertilizers. The fertilizer is then guided from the cultivator working tool, where the outlet is optimized so that the fertilizer is best placed in the loosened soil zone. This ensures a uniform dose and even infiltration into the soil profile. Emissions of ammonia and carbon dioxide are eliminated as much as possible.

STRIP-TILL & SYNCULT



OIL & FEED TECH



HEXANE FREE
TECHNOLOGIES®





complete pressing technology for extracting vegetable oils
 kompletní lisovací technologie pro získávání rostlinných olejů
 komplette Presstechnologie für die Gewinnung von Pflanzenölen
 полная технология прессования для производства растительных масел
 kompletna tehnologija presuvavanja dla oduzhanja roslinnych olij
 kompletna technologia wytłaczania pozwalająca na otrzymanie olejów roślinnych
 technologie de pressage complète pour obtenir les huiles végétales
 tecnologia completa de prensado para obtener aceites vegetales
 tehnologie completă de presare pentru obținerea de uleiuri vegetale
 kompletna presovčna tehnologija za izvlíčanje na rastitelni masla
 komplett növényi olaj sajtoló technológiák
 presavimo tehnologinè jřanga augaliniam aliejui išgauti
 kompleksa presėšanas tehnolģija augu eļļu iegūšanai
 tāistehnologia õliseemnete pressimiseks



THINK GLOBALLY
ACT LOCALLY



HEXANE FREE
TECHNOLOGIES®

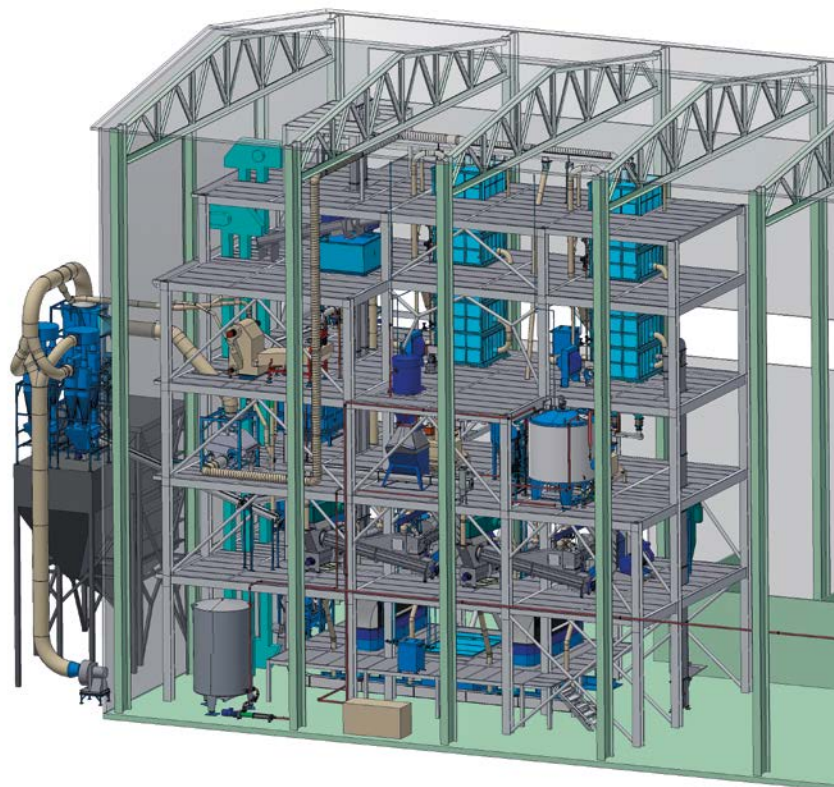

complete technology for processing vegetable oils
kompletní technologie pro zpracování rostlinných olejů
komplette Technologie zur Verarbeitung von Pflanzenölen
полная технология для переработки растительных масел
комплектна технологія для переробки рослинних олій
kompletna technologia pozwalająca na przygotowywanie olejów roślinnych
technologie complète pour traiter les huiles végétales
tecnología completa de procesamiento de aceites vegetales
tehnologie completă pentru prelucrarea uleiurilor vegetale
комплектна технология за преработка на растителни масла
komplett növényi olaj feldolgozó technológiák
technologinė įranga augalinio aliejaus perdirbimui
kompleksa tehnoloģija augu eļļu pārstrādei
täistehnoloogia taimeõli töötlemiseks



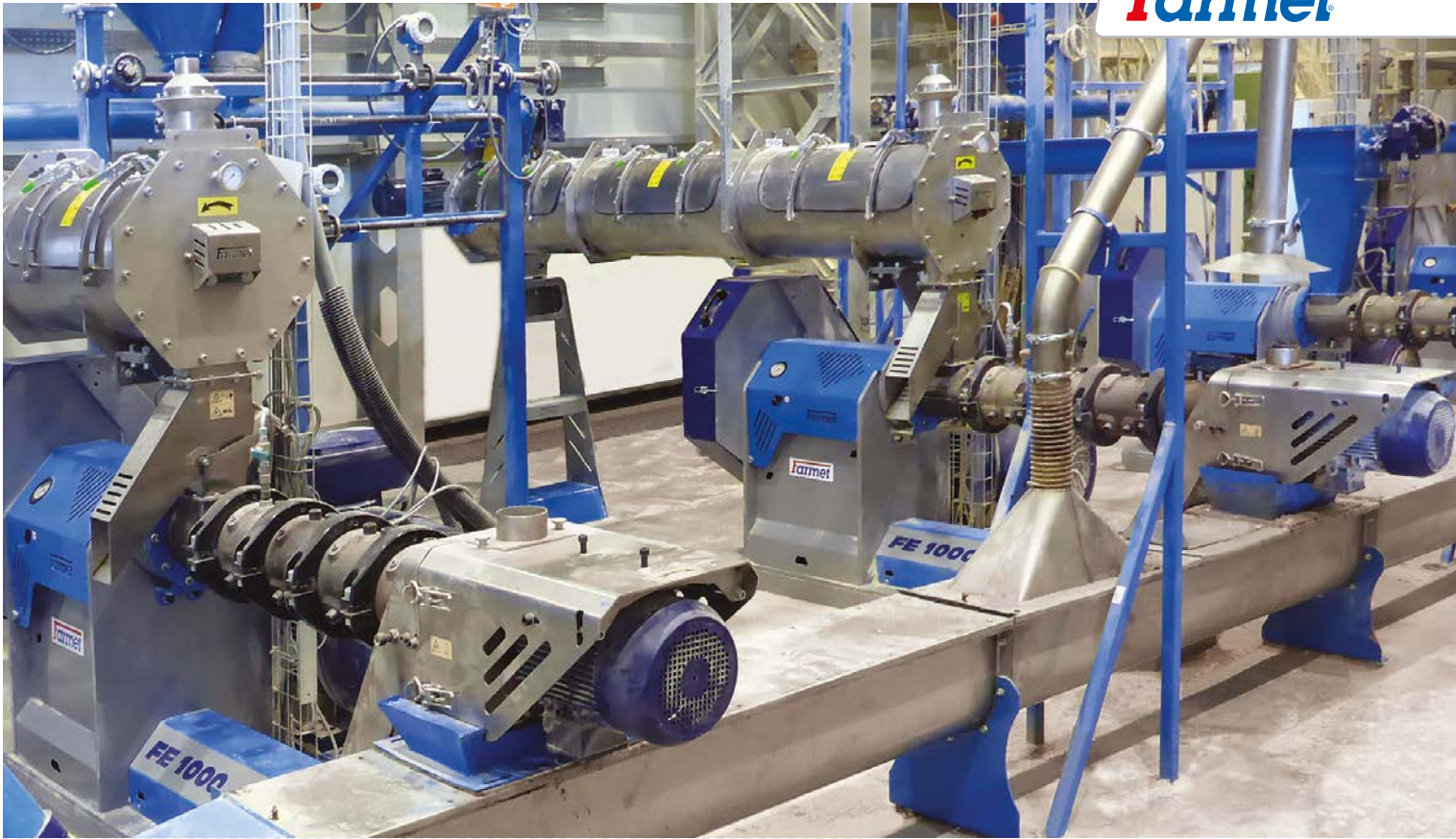

extrusion lines for the preparation of fodder
 extruzní linky pro přípravu krmiv
 Extrusionslinien für die Vorbereitung von Futtermitteln
 линии екструзии для производства кормов
 екструзійні лінії для підготовки кормів
 linia ekstruzji do przygotowywania pasz
 lignes d'extrusion pour la production des fourrages
 plantas de extrusión para la preparación de piensos
 linii de extrudare pentru prepararea furajelor
 екструзни линии за приготвяне на фураж
 takarmány előkészítő extrudáló sorok
 ekstrudavimo linijos pašarų ruošimui
 ekstrūzijas līnijas lopbarības sagatavošanai
 ekstruderliinid loomasööda tootmiseks



HEXANE FREE
 TECHNOLOGIES®





www.farmet.eu

Business representative of Farmet a.s.

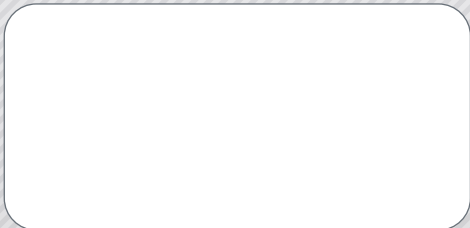

Farmet a. s.
Jiřinková 276
552 03 Česká Skalice
Czech Republic

AGRICULTURAL MACHINERY

Tel.: +420 491 450 122
Fax: +420 491 450 136
E-mail: dzt@farmet.cz

OIL & FEED TECH

Tel.: +420 491 450 116
Fax: +420 491 450 129
E-mail: oft@farmet.cz

