

QUICK START

SOFTER

SF500PRO | SF600PRO

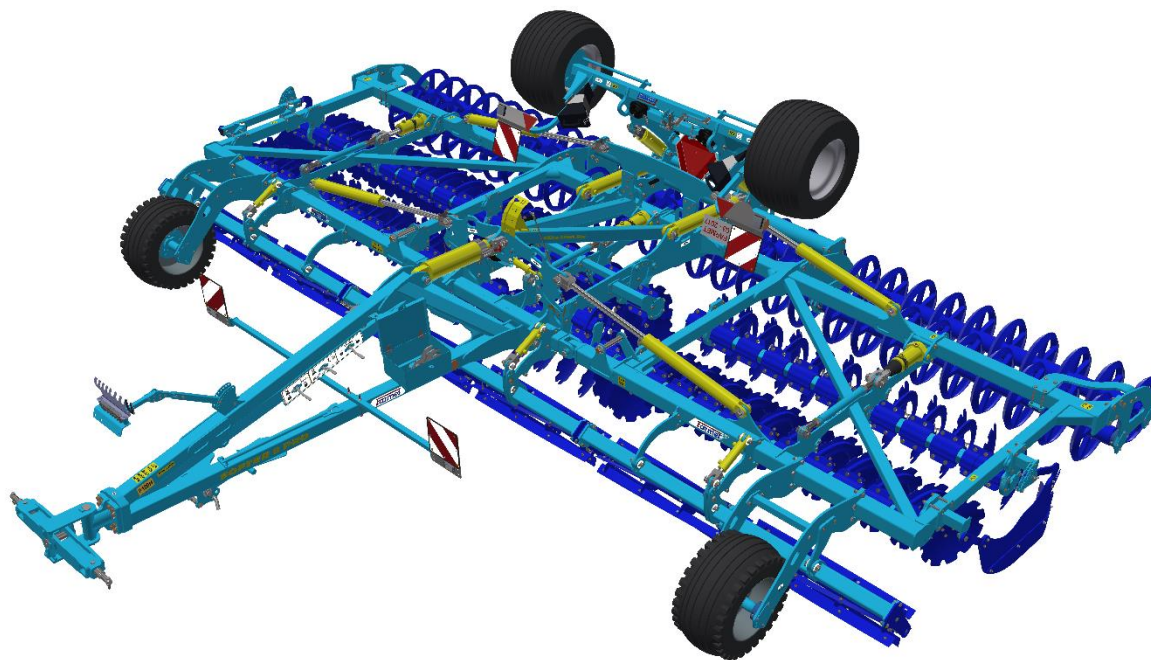

Издание: 4 | действительно от: 1. 4. 2024



- ☞ Návod Quick Start nenahrazuje návod k použití!
- ☞ The Quick Start guide is not a substitute for the instruction manual!
- ☞ Die Schnellstartanleitung ist kein Ersatz für die Bedienungsanleitung!
- ☞ Le guide de démarrage rapide ne remplace pas le manuel d'instructions!
- ☞ Руководство по быстрому запуску не является заменой инструкции по эксплуатации!
- ☞ Podręcznik szybkiego startu nie zastępuje instrukcji obsługi!

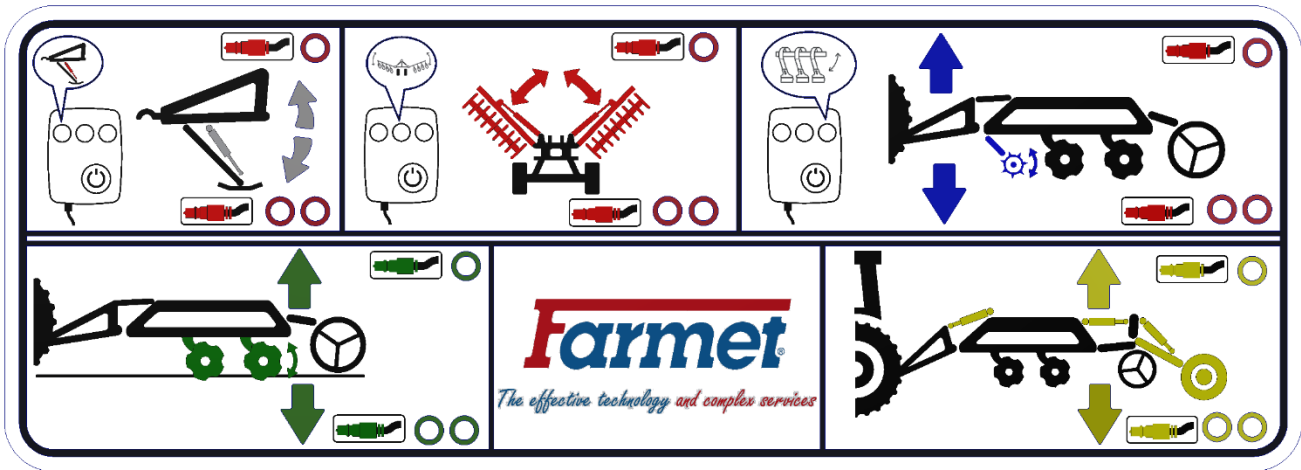
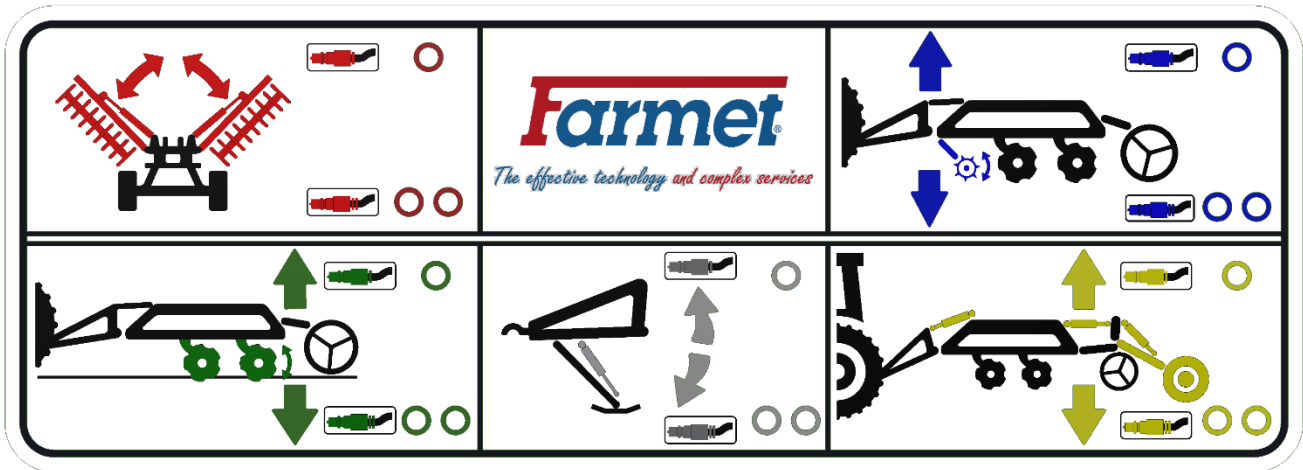

Порядок раскладывания машины - рабочее положение

1a		
1b		
2a		
2b		
2c		<p>80 bar/1160 Psi</p>
2d		
3a		

2a

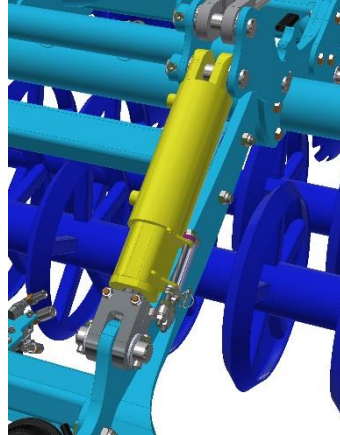
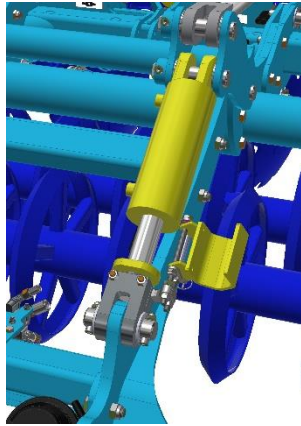

2b

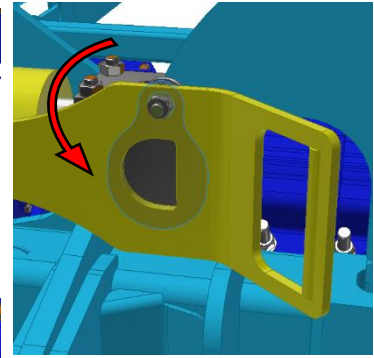
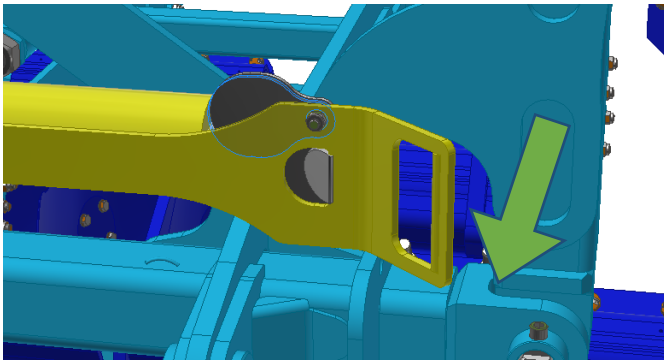

2c

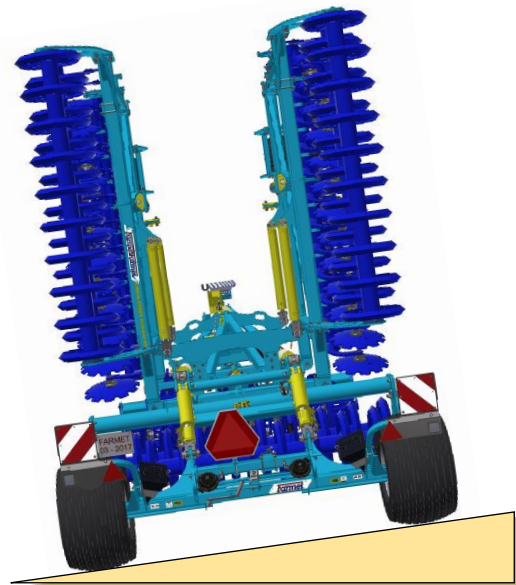
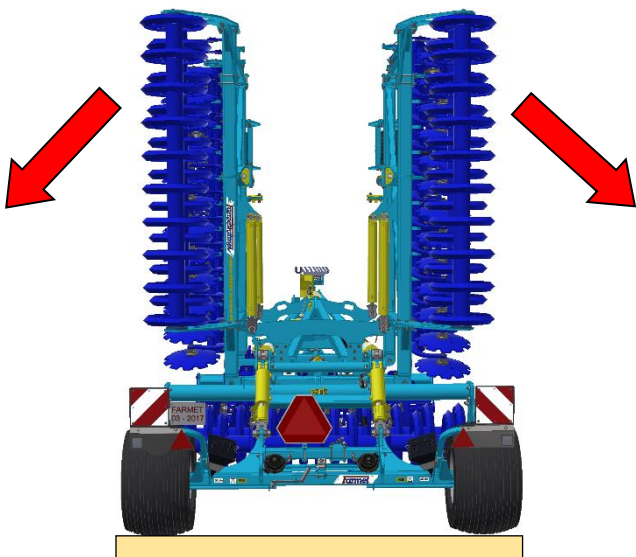

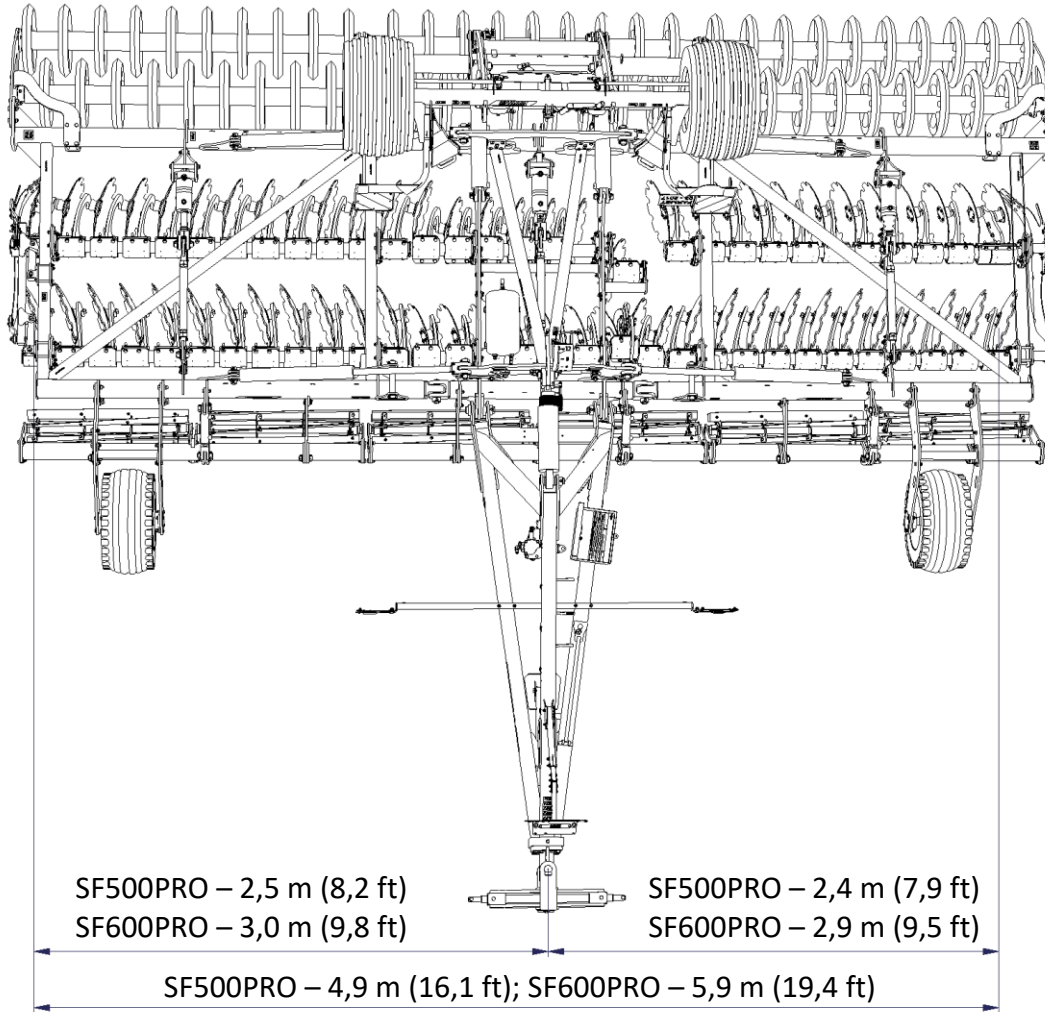

1

h [cm / in]		
0		70 / 28
2		64 / 25
4		59 / 23
6		53 / 21
8		47 / 19
11		TRANSPORT

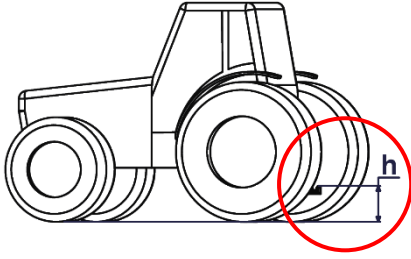

2

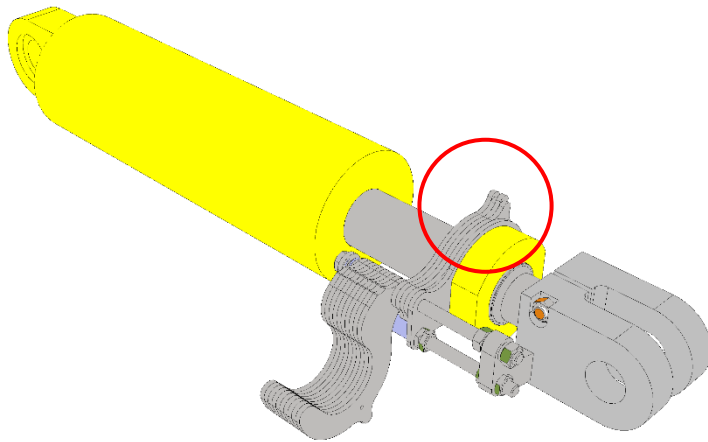

3

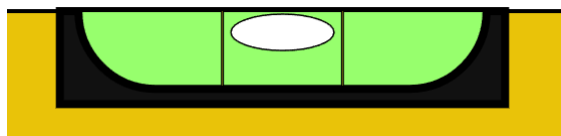
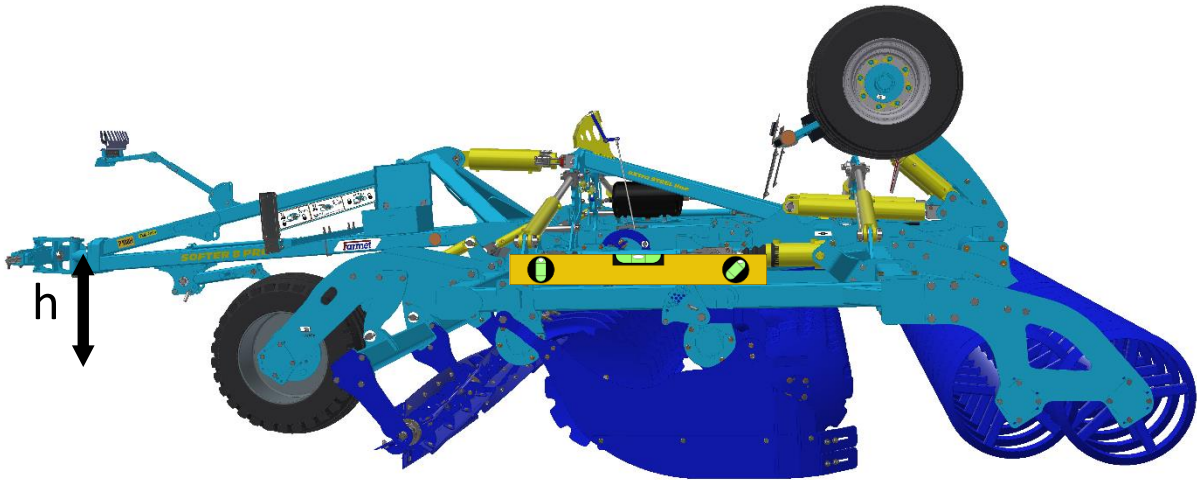

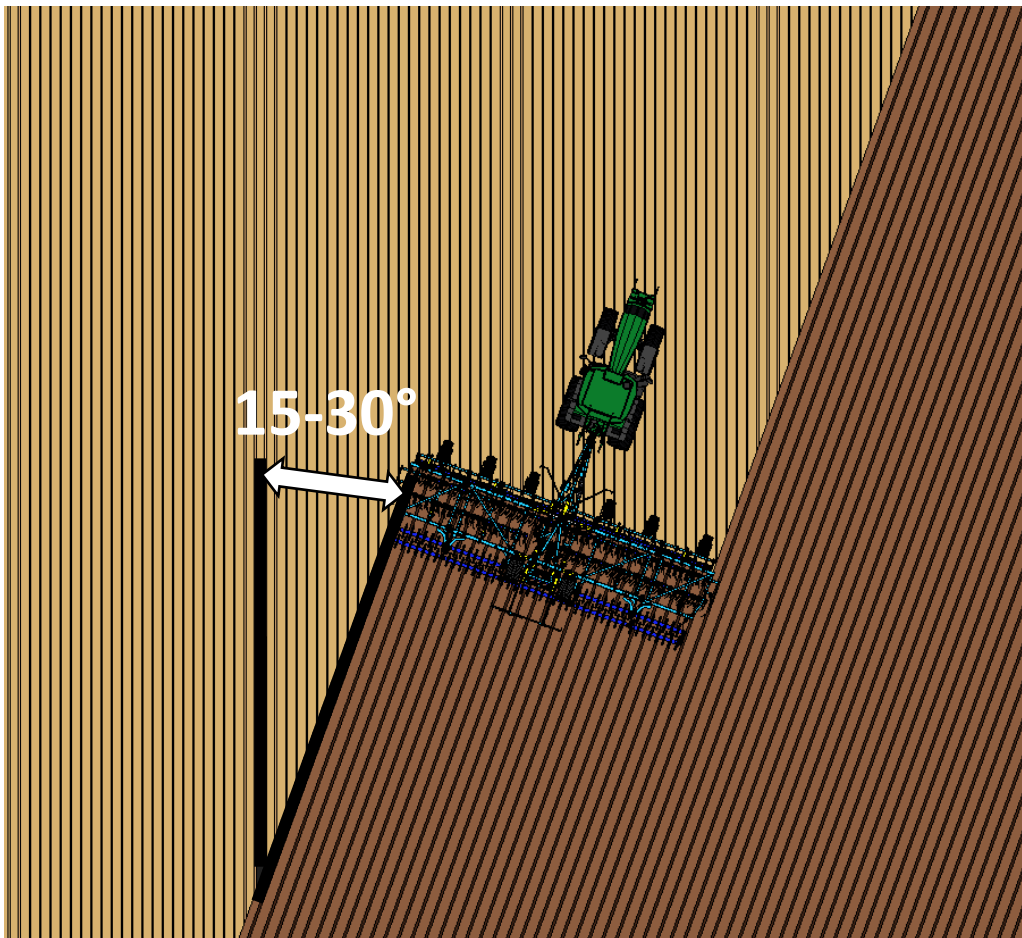
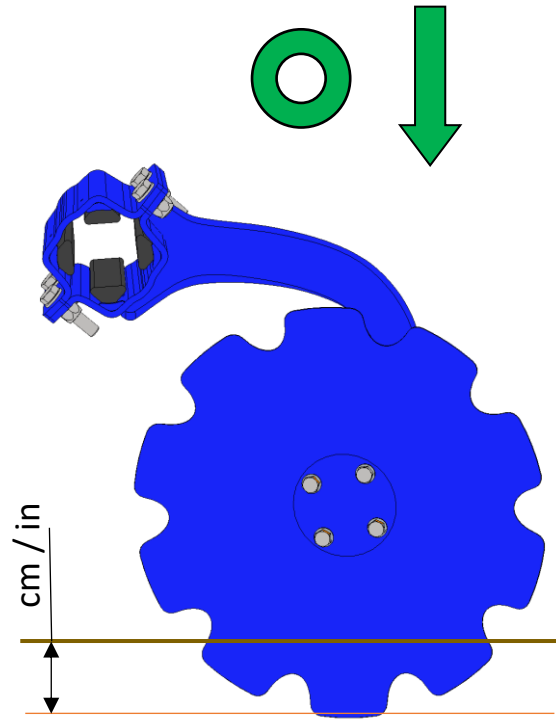

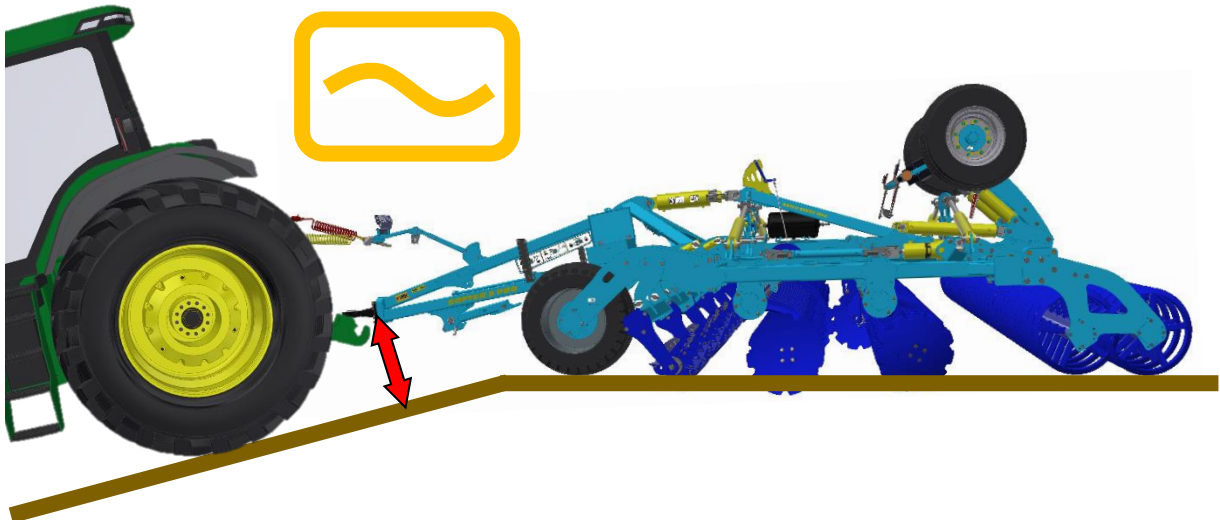
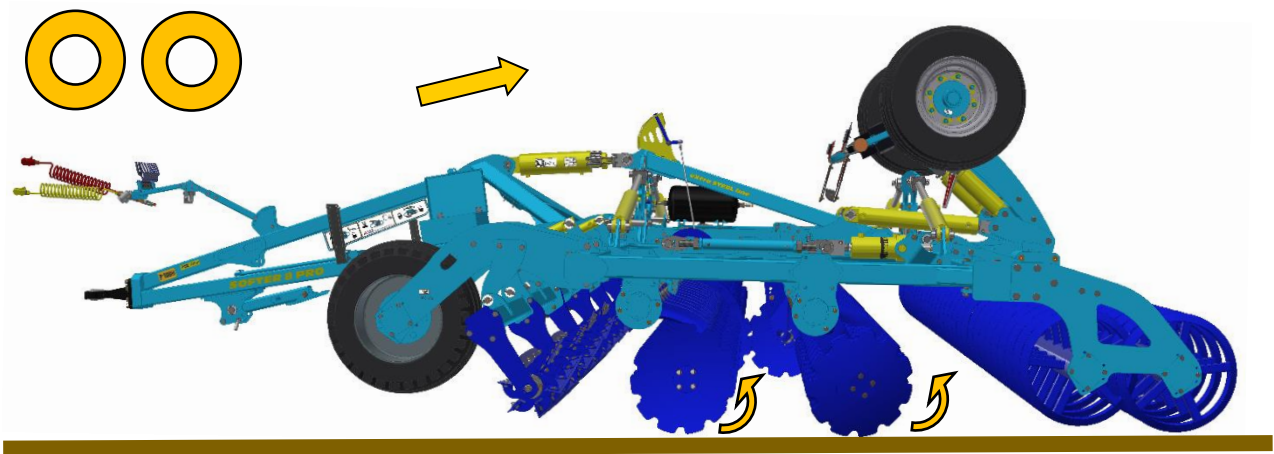
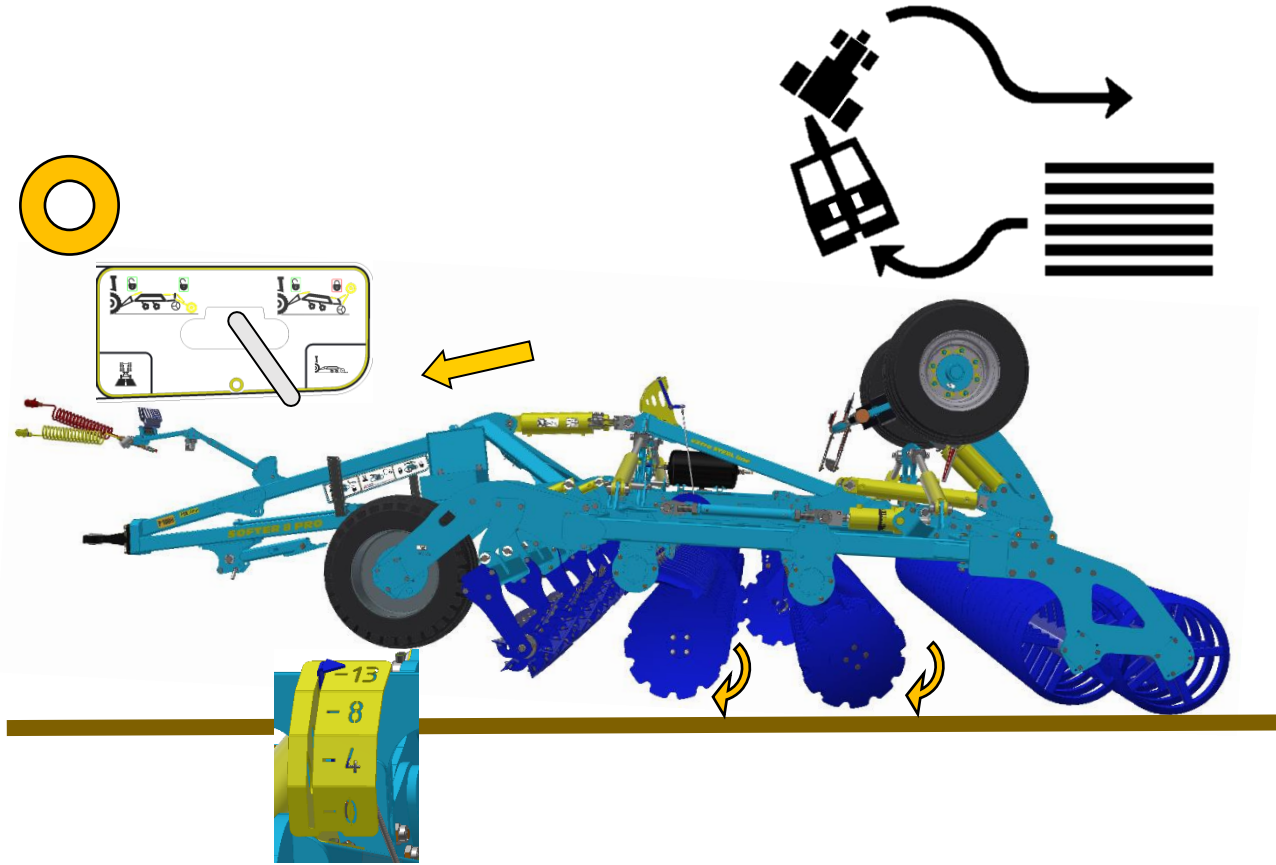

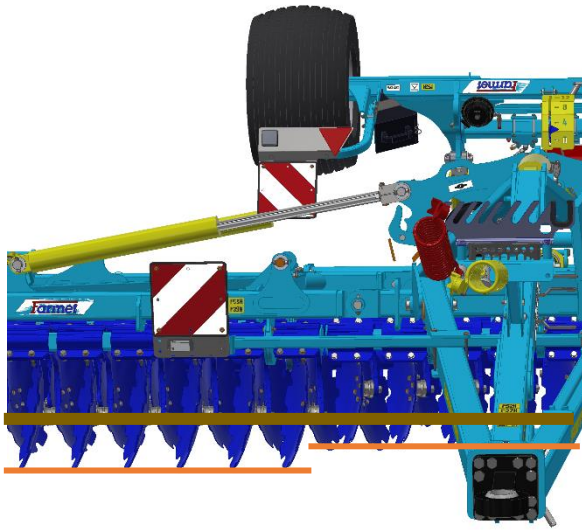
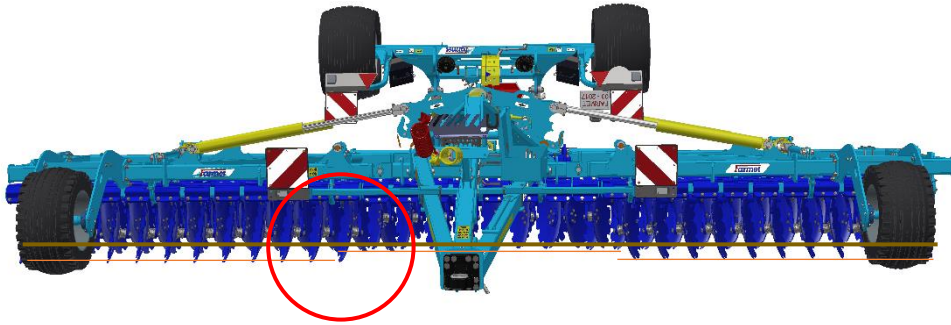

10 s

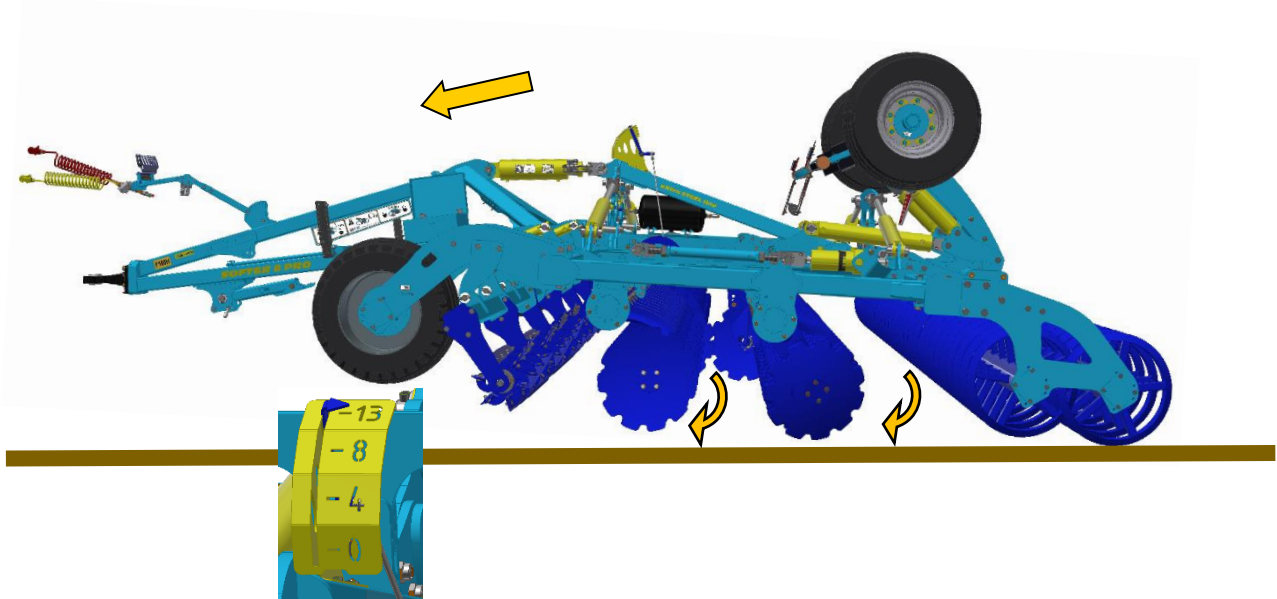

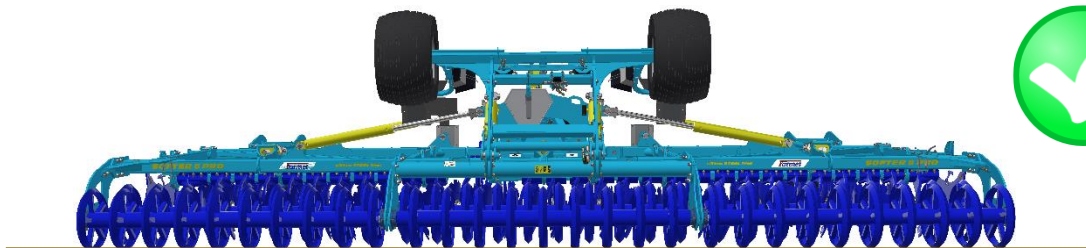
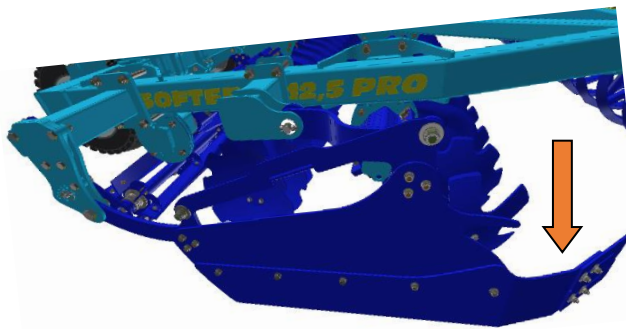
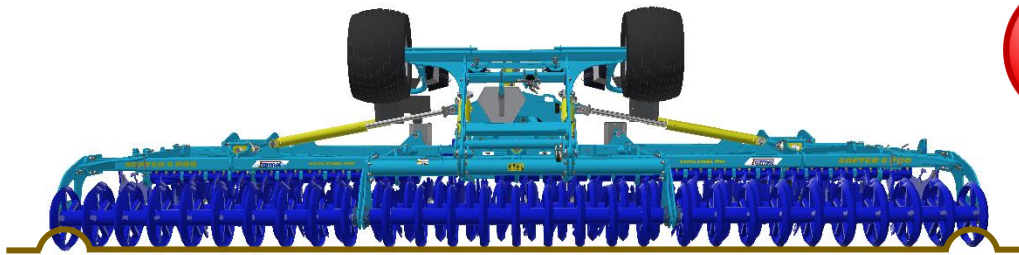
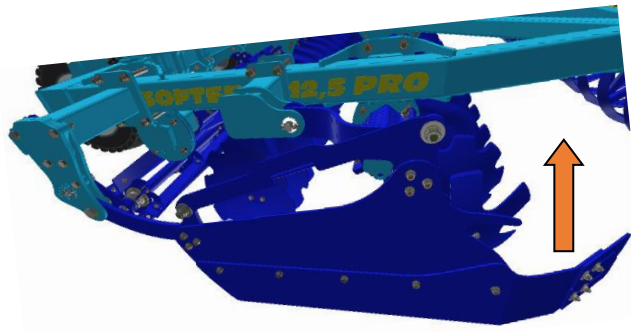
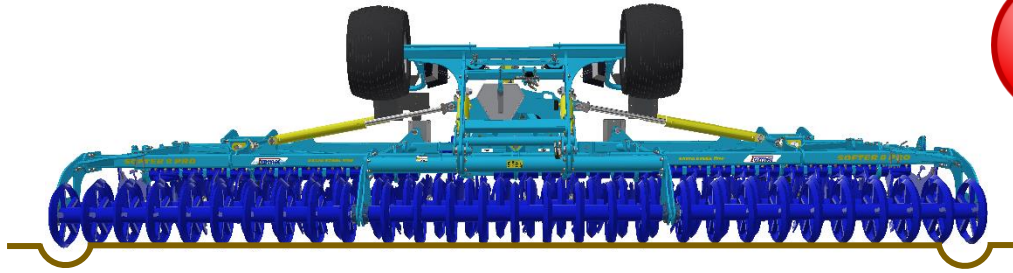

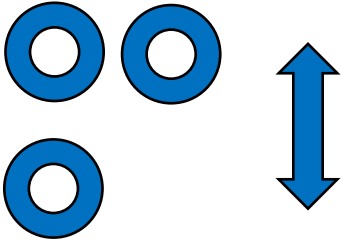

MAX 70 bar/1015 Psi

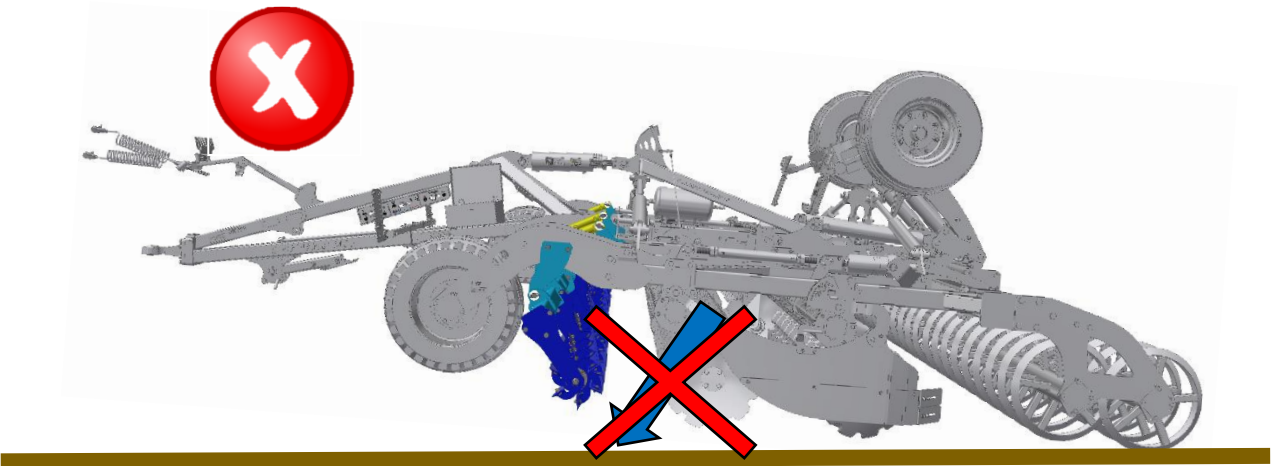
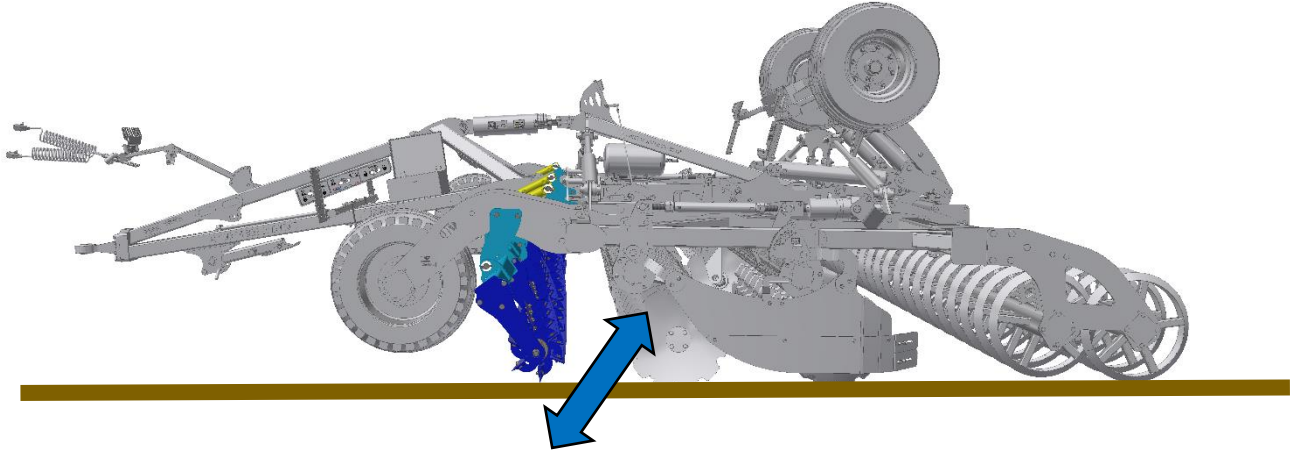

Порядок складывания машины - транспортное положение

1a		
1b		
1c		
1d		
1e		
2a		
2b		
3		

1d

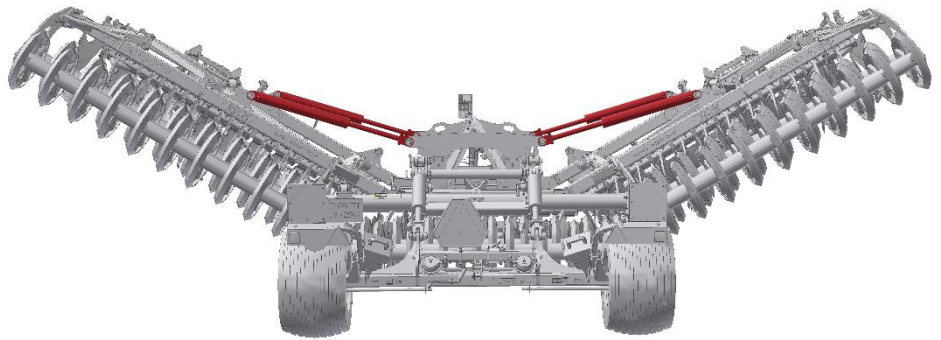
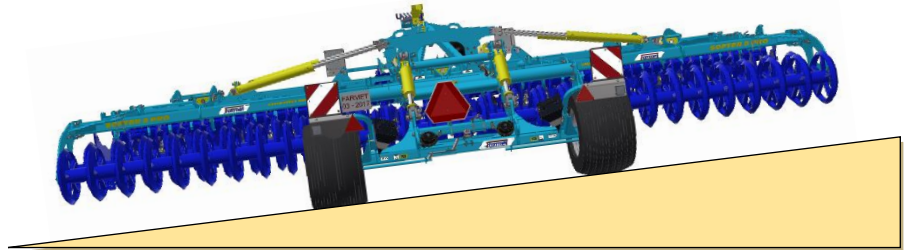
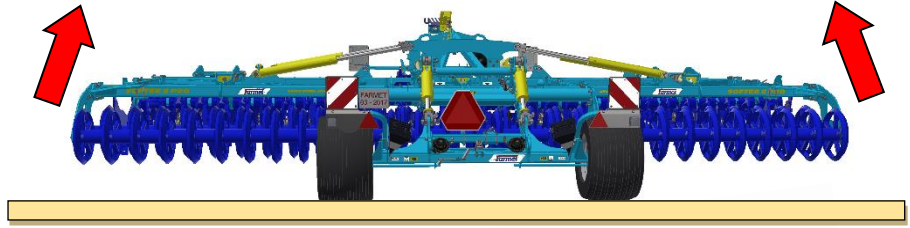

1e

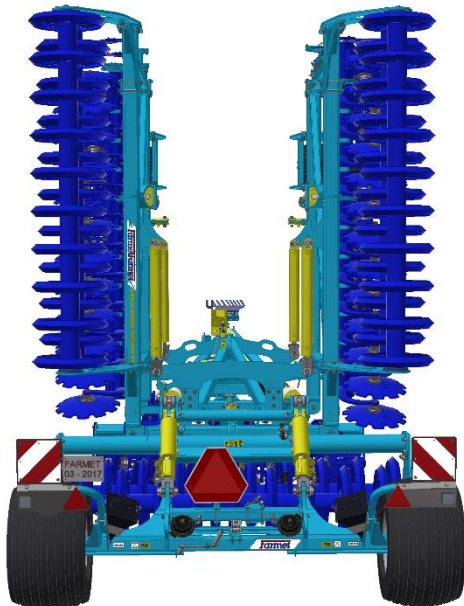
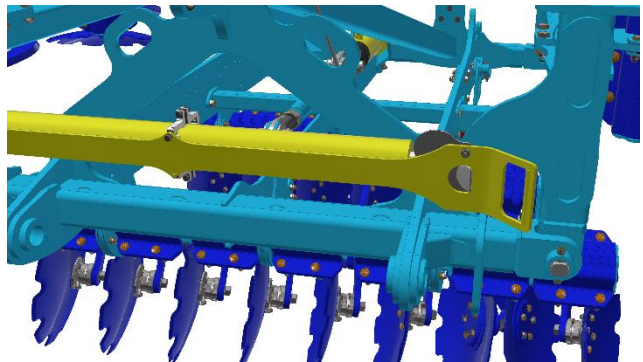

 $p > 6 \text{ bar}$
(87 Psi)

